

# Exterior Siding Details and Best Practices

MARCH 2020



**NAKAMOTO  
FORESTRY**

## General Exterior Siding Installation, Layout, Furring, and Fastener Tips For Yakisugi “Shou Sugi Ban” and Other Softwood Products

March 13, 2020 Beleck

### Contents

1. Introduction
2. Furring and Screen Walls
3. Layout, Bond Lines, and Butt Joints
4. Fasteners
5. Trim, Moulding, Batts, Flashing, etc.
6. Oil Finishes and Touch Up
7. Other General
8. Detail Diagram Appendix

### 1. Introduction

The best practices included in this guide have been gleaned from installation carpenters in both North America and Japan who follow traditional trade practices combined with modern wall assembly developments. The design detail option suggestions in the Appendix have been borrowed from numerous architects and builders that we have worked with. Customers that choose our products are planning for long term ownership and want to be surrounded by beautiful natural materials. Projects in which our products have been specified are overwhelmingly very well designed and built, and we appreciate all of you raising the bar in terms of both design and construction quality.

It is important to note that standard practices are not necessarily best practices when it comes to specification and installation. Much traditional carpentry and millwork know-how commonly followed pre-WWII is ignored in today's world due to a focus on square foot build cost. In North America square foot build cost is a primary design driver due to a short average home ownership period, comfortable and convenient lifestyle being prioritized over aesthetic beauty, and a focus on home ownership as primary vehicle for asset accumulation. This encourages low quality construction.

Yakisugi “shou sugi ban” is heat treated to maximize wood longevity, minimize required maintenance, and be rot, bug, and fire resistant. However, it is wood just like any other, and same as any other wood siding material correct installation is the most critical factor for siding longevity. We know our product very well, have studied how different installation specs affect wood and color longevity over the long term, and have developed these guidelines for best siding longevity with minimal maintenance. We do not know everything, and we often receive technical guidance from architects or carpenters in the field. We assembled these guidelines as a resource for our customers to help you decide the best installation spec match to your individual project. However, these are no more than minimum suggestions and Nakamoto Forestry North America accepts no liability related to these suggestions.



Each topic is a laundry list of rules and suggestions, and our detail diagram Appendix has layout and detail suggestions to help with design development.

## **2. Furring and Screen Walls**

### Background

Standard North American siding installation practices are in flux, mainly due to the transition from paper to resin vapor barriers. There is also a large variety of wall system and material options available today, creating challenges in terms of penetration details, fastening spec, furring thickness, fire resistance, and flashing. However, the most important modern development in terms of siding installation spec is that most Water-Resistant Barriers (WRB's) do not allow wood siding to breathe or can be degraded by tannin bleed. What this means is that long term wood integrity depends on an air gap being designed in between the WRB and wood siding. Additionally, since wood siding is subjected to harsh temperature and moisture fluctuation season to season and day to day, rigid furring must be used to create this air gap in order to keep the wood siding wall plane flat over the long term.

It is universal with modern materials and construction that any kind of wood siding needs to be installed over furring in a rain screen. North America has not caught up with Europe and Japan due to cost pressure and lack of local code regulation. Installation directly to the WRB will not allow the siding to dry out properly and will cause rot due to promoting fungal growth. Also, if siding is in direct contact with the WRB, tannins in the cladding can leach out as the wood absorbs atmospheric moisture, in some cases chemically degrading the WRB. Lack of back-venting can allow the siding to heat up dramatically resulting in dimensional movement, increases the likelihood of premature oil finish weathering, and compromises thermal envelope efficiency. Vented walls cool the structure during the summer and heat it during the winter. The days of installing directly over wood shiplap or felt are over due to modern building materials and practices.

Furring is also referred to as "lathe", "stripping", "purlins", or "runners".

### Furring Types & Tips

There are many engineered furring products available, such as perforated resin, corrugated metal, and pressure-treated ply stripping. We recommend using #2 & better grade solid-sawn wood furring since it is superior to engineered products. Wood against wood dries most quickly, and the speed that siding dries out is proportional to siding longevity.

Modern pressure-treated plywood stripping has improved water-proof glues so should last longer before delaminating than plywood from the past, and we expect that they should stay fast for the lifetime of the structure especially since held down by the siding nails. However, delamination or veneer swelling can be a potential concern. We strongly recommend against using any kind of compressed board materials for furring.

- Furred screen walls can either be open (vented) or closed. Open screens will dry the walls out more quickly and offer better insulation. Closed screens are better than applying the siding directly to the vapor barrier.

# NAKAMOTO FORESTRY

- Open screens generally have a screened intake at the bottom and screened exhaust at the top of the wall, creating a vent. This will keep most bugs out. A vented screen wall is often created by leaving a gauged shadow gap (std @ 3/16") between square edge planks for full breathability, but bugs may get into the wall cavity. If installing an open shadow gap make sure that the substrate is completely black in order to blend with the shadow cavity.
- 3/4" or thicker solid sawn furring can easily be shimmed out in low spots from the back side every foot or two, but 3/8" or 1/2" furring will be more difficult to achieve a flat plane with. Pull a string over the vertical, horizontal, and both diagonal planes to judge flatness for each wall plane as needed. Pay attention to special locations such as adjacent to windows or doors since framing can be especially distorted there. Flashing can "pooch out" the wall plane, especially if fasteners are not driven perpendicular and flush.
- Dimple wrap, breathable mesh, or drain wrap products are not furring, do not qualify as screen walls, and do not offer all the longevity and thermal benefits of a proper furring bed for wood siding. They may delay siding rot for a few years over direct WRB-to-siding contact, but standalone they do not offer full venting or cooling of the structure. Additionally, they will not hold a wall plane flat since some areas may be pressed down more than other areas during install due to lack of a rigid furring bed plane. A flexible substrate plane will not prevent boards from cupping or other dimensional movement over time. They are recommended as a substrate bed between the sheathing/WRB and shimmed horizontal wood furring in the case of a vertical siding installation.
- For walls vented up to 20' height, a furring thickness minimum of 3/8" is recommended and 1/2" minimum is preferred for more air flow. Over 20' height we recommend minimum 3/4" thick furring for ventilation of additional wall surface area. A vented bond line with z-bar (with or without belly band or other trim) can be designed in to each floor or every other floor on multi-story projects.
- If there is an engineered substrate such as rigid insulation or fire-resistant fiber underlayment between furring and sheathing we recommend thicker furring such as 4/4 or 5/4 cedar decking, or nominal 2x thick stock. Nominal 6" decking can be ripped into two strips. 4/4 or thicker furring is easier to achieve a flat wall plane with since it will deflect less than 3/4" thick furring over an undulating substrate.
- With our nailing pattern of 2 headed ring-shank face nails every 16" on-center minimum, a general rule of thumb for sufficient fastener holding strength is minimum 1" depth of fastener penetration. This is usually achieved with 3/8" thickness or 3/4" thickness furring plus sheathing thickness. Sufficient fastener purchase can generally be achieved by a combination of 3/4" penetration through mill-certified plywood or solid-sawn dimensional furring, plus minimum 1/4" fastener blow-out on the back side past the furring or sheathing. The exposed fibers will lock in to the fasteners' ring shank and give similar holding strength to full 1" penetration. It is important to check local building code to confirm that siding substrate detail is sufficient for compliance—for example on the fastener type or penetration depth in regions with severe weather.
- While 1.5" width suffices for interval nailing strips, a butt or other joint between boards requires at least 3" furring width. The reasoning behind this is that it is best to nail at least 1.5" from a butt or scarf cut at the end of a board, and the fastener must be at least 1/4" in from the furring edge to avoid split-out. This can be cheated with an angled nail when furring is a 3" width, but this is technically difficult and is not ideal. In the case of a nominal 4" or 6" width, proper purchase can be easily achieved with a perpendicular face nail. All of these dimensions are minimums.



# NAKAMOTO FORESTRY

- To be clear, we recommend 3" furring width for interval nailing strips, and 5" furring minimum width for termination and all other nailing strips. Additionally, we always recommend high-grade solid-sawn furring to be used over pressure-treated plywood or resin furring products.
- Furring spanning between girts, perpendicular stripping, rigid insulation, or other spans must be rigid enough to stay straight instead of deflecting (bouncing) during siding attachment. This means a minimum of ¾" thickness, and we generally recommend 4/4" or thicker if spanning more than 12" on center between supporting stripping.
- Cedar, Cypress, Douglas Fir, Pine, or other dimensionally-stable species can be used for furring. Preservative-treated wood is not necessary in most situations. If preservative-treated wood furring is used, confirm with the chemical treatment and WRB manufacturers that the chemicals will not degrade the WRB.
- Screw furring to the substrate, namely the structural framing. Then nail siding to the furring. Blocking within the stud wall should only be necessary in some locations. It should not be necessary to add blocking along the entire perimeter, for example if furring layout is 16" on-center and stud wall layout is 24" on-center. In a case like that rethink your wall system since the furring can be screwed to the sheathing (that is already installed to the framing with code-regulated fastening spec), and then the siding fasteners will penetrate the furring and sheathing, further locking the assembly together.
- Square horizontal furring works just fine and does not need to be bevel-ripped or back-relieved. It will weep through the siding joints and should not puddle. If the designer does not feel this is sufficient for their build, then furring can be kerfed or routed perpendicular to the grain on the backside every several inches or so for weepage and ventilation. Or a mesh or dimple-type mat product can be installed under the nailer purlins. Two other options are to either install the furring diagonally (see Appendix diagram N1.15-A), or start with a vertical lathe bed under the horizontal nailer purlins in a crisscross vented wall assembly (see Appendix diagram N1.16-B). Some jurisdictions may require this as standard on vertical siding applications.
- Make sure furring is dry when installed, and deselect or defect as needed to achieve a structural grade.
- It is better to have a flashing profile with nail flange between sheathing/WRB and furring, not between furring and siding.

### **3. Layout, Bond Lines, and Butt Joints**

- For vertical installation there is generally no need to pop layout lines; simply plumb every third or so row.
- For horizontal installation work off of a horizontal baseline and work up or both directions. Or if a complex or large install, a full structure wall grid can be popped with chalk and a long plumb stick to avoid unforeseen layout issues during installation. This is effort well spent.
- For story pole or popped chalk gridlines S3S profiles can have different reveals due to shadow gap or overlap spec, but our standard shiplap reveal is 5 5/16" on center. This allows just enough play to insert boards in between two already installed. In lieu of measuring this out, the installer can also tack cutoff shiplap blocks as place-holders until the intermediate rows are installed. This is for example when the installers are moving fast installing full dimension boards, and do not want to take the time to cut a notched or other difficult board and therefore plan on slipping it in later. For



# NAKAMOTO FORESTRY

example around a window, vent, mechanical termination, or other component that will be installed after the main siding field for logistic or availability reasons. If the reveal is set at 5 ¼", then boards will unduly need to be forced in later especially if not laser straight. And if over 5 5/16" reveal is left there is a chance that shrinkage may expose the substrate.

- Scarf joints on horizontal installations have two purposes: structural since they will allow deflection and minimize buckling; and cosmetic since the painted/oiled cut end will not show the substrate below and so will blend in if the boards shrink.
- Make sure to install with intentional tolerances to allow for board expansion and contraction.
- Butt joints ie bond lines can be either staggered or inline.
- Staggered butt joints should always have two unbroken rows of siding between joints.
- Butt joints or other layout are never random. In siding everything is planned and laid out in advance, whether the client notices or not. Decide your layout and bond line pattern before starting.
- Horizontal butt joints can be square-cut or scarfed at 15deg, 20deg, or 22.5deg. Vertical butt joints should be scarf cut as a weep with similar bevels unless there is a consistent bond line with z-bar or equivalent flashing.
- Some jurisdictions may require that shiplap installed in horizontal layout must have all butt or scarf joints flashed over the preceding row with resin, paper, or metal flexible sheet stock.

## 4. **Fasteners**

- Softwood siding should never be blind nailed, despite what standard practice might be. T&G profile blind nailed will move out of a flat plane in future and will end up needing to be face-nailed eventually (especially since it dries more slowly than lapped profiles). Do not believe guidance otherwise.
- Use two headed ring- or screw-shank face nails minimum every 16" on center. Do not expect that one nail on the female edge of shiplap will hold the male end down, since the wood will want to cup over time and two edges pushing against one nail will pull it out. Cypress is very soft wood and casing nails will pull through when it starts to move instead of holding the siding in place. Do not pin, staple, nail, or screw the male lap since it is too thin for structural integrity. To repeat: use 2 headed ring-shank face nails every 16" on-center, and never use casing nails for exterior installation.
- Unless contrasting color is desired use painted fasteners to match the siding color. Note that stainless steel must be etched before painting
- Make sure that fasteners used to install siding have minimum one-inch penetration for proper purchase into substrate. Some jurisdictions may allow a ¾" substrate (such as floating furring or skip-sheathing) if there is enough fastener length for minimum ¼" blow-out penetration past the substrate (see furring section above).
- Drive each nail ¾"~1" from each edge since too close to the edge may split out and too close to the inside of the plank will allow it to cup. Nail at least 1.5" in from an end cut, and 2" in from a miter cut.
- Miters or other joints can be solidified with pin nails. Stainless pin nails may be preferred by local code compliance and will last longer, but uncoated or interior grade pin nails will corrode after weather exposure and often offer better joint holding strength.
- Many traditional carpenters in Japan believe that uncoated siding nails will have better purchase into the substrate than stainless or coated nails due to corrosion bond with the substrate. However,



# NAKAMOTO FORESTRY

due to ferrous streaking and local municipal code compliance we recommend #316 stainless steel fasteners.

- We recommend painted stainless nails if fasteners should match siding in color. Stainless steel must be etched prior to painting in a two-step process, and an industrial-grade highly UV-resistant paint should be used. Note that nails painted with dark colors will show more contrast against the stainless-steel underneath when exposed due to pneumatic nailer plunger or hammer face impact abrasion (ie the nailer or hammer scuffs the waffle-head ridges). This is standard and not a defect.
- Nail head paint abrasion from the nailer plunger or hammer face is the nature of the product. If the client doesn't like the abrasion then the installer can touch up nail heads with a matched color pen available from metal fabrication suppliers. DO NOT touchup nail heads with wood touchup oil and a paint brush since it will blemish the adjacent siding and you will have to repaint the entire structure to even out the blotchy, dotted nail lines.
- Use 10~20psi lower pressure on the nailer line regulator compared to standard in order to prevent nails from being depressed below flush (ie back off from 110psi standard pressure to 90psi for a better final appearance). Do not bump-nail as framers or roofers do since the pressure will countersink the nails. Slightly proud initial nail position with the nailer is preferred over trying to flush-nail in one go. This is to compensate for substrate density or hardness variation, also for straightness inconsistency in the plank stock or flatness in the substrate. After nailing off each wall section with the nailer go back over the section with a round-faced hammer, pushing each board in with the gripping hand and driving the nails flush with the hammer. This is how a flat plane is achieved, and is minor effort well-spent. Otherwise the siding will noticeably appear out of flat when the sun or other light source is near flush with the wall plane.
- Be careful not to over-drive by hand since even if hammer-moon blemishes do not appear immediately, they may appear in the future. The Suyaki soot layer can be easily damaged and will erode more quickly at impact locations, noticeable only after 10 or more years.
- In future if the siding starts to cup or otherwise move, add more face nails to suck the plank back up against the furring. Nails are good. The wider the board and the drier the climate, the more the planks will want to cup.

## **5. Trim, Molding, Batts, Flashing, etc.**

- Yakisugi is normally 3/8" thick, but Nakamoto Forestry North America inventories a maximum standard thickness of 9/16". 3/4" is the most common wood siding thickness in North America and is often an assumption in project specifications. In the case of yakisugi "shou sugi ban", form follows function for the plank thickness spec. Thin stock is actually necessary for yakisugi products due to the flash heat treatment. Burning a thick plank at high temperature causes dramatic moisture content variation between the surface and center of the planks, resulting in warping, crooking, crowning, etc. Heat treatment will not penetrate as well either. 9/16" is sufficiently thick to act as an exterior skin and to easily install with the same methods traditional for 3/4". Yakisugi is very rarely burned on the back side, and then only for fencing applications (we do not offer this as an option).
- Due to heat treatment process parameters yakisugi is by nature a thin-plank product not available in 4/4 or thicker trim stock, T&G, or other profiles. We offer matched surface S3S profiles 9/16" thick, or molding or batts can be ripped from our standard plank profiles. Since yakisugi trim stock is



the same thickness as the field, it can either be installed over the field or another detail solution implemented. Thick-stock non-heat-treated wood is also often used as molding with a stained finish to match or contrast with the yakisugi field, and the siding field can be butted to it or the trim rabbeted to receive it. Outside corners can be mitered and pinned, or overlapped.

- It is better to have 1/8" gaps between siding and trim, and to paint even hidden spots with touchup oil. For example, if the siding field is let into a rabbet in the window and door casing, make your rabbets large enough so that wood contact is minimal. Or if butting the siding field into casing, corners, or spigot/outlet blocks, leave a shadow gap and don't caulk it. Another example is that it is better to paint miters then pin them together wet instead of gluing the miters.
- It is common in modern architecture to use folded or extruded metal profiles on corners or other transitions instead of a wooden trim detail. The field can be run to flashing and door and window penetrations. Flashing specifications are the same as standard wood plank siding.

## 6. Oil Finishes and Touch Up

- Thick stock material can be matched in color to the siding field generally with 1 coat of alkyd oil finish, or 2 coats of traditional oil finish. In some cases (generally if the oil finish is not black), the un-heat-treated wood will not easily match the siding field. Note it is common to have a contrasting color trim.
- If narrow batts are ripped from our wider planks then the ripped edges can be painted to match the face using touchup oil we supply. Use a weeny roller on the ripped edges and wipe off any drips or smears on the finished faces before the oil dries. In cases of large louvered fields or board and batten layouts this can be accomplished in volume quickly with proper table saw and saw horse setup. Edge-painted batts can be stacked in layers with sticks between to prevent contact and minimize movement.
- Traditional oils will dry slowly (2~7 days) so are easy to touch up and will not get a dry edge. Waterborne alkyds or interior polyurethanes dry very quickly (10~120 minutes), so test first to judge time and plan touchup or painting progress accordingly in order to keep a wet edge.
- Applying a second coat of oil after installation will give maximum color longevity to the siding, and can be done by a painter by roller, brush, or spray rig. If rolled or sprayed please back-brush with a 5"W or equivalent professional-grade stain brush. The absolute best finish can be accomplished by applying a second coat by hand with a rag after install, but this is simply too much labor for most large scale projects and most people wouldn't notice the difference anyway.
- Note that a thicker coat of oil will cause the sheen to increase in gloss, and pigment color to become more solid. We use oils that are slightly satin since completely matte oils do not look good on our products. Everyone thinks they want a matte finish and there is a general aversion to glossy samples, but matte finish on high-grade softwood siding simply does not look good and will collect pollen. The more oil applied the glossier the finish will appear, so be careful and sparing with the oil when touching up or applying a second coat.
- Touchup can be done by wet rag or brush, then residue blended in with a dry rag.
- A good practice is to keep touchup oil for painting cut ends near the cut station, in a small can inside a 5-gallon bucket, with a piece of ply or other wood as a lid to keep sawdust out. Tie a lightweight piece of wire to the brush handle and bend a hook in the end to hang from the bucket lip



# NAKAMOTO FORESTRY

inside the bucket. That way the brush is readily available and stays clean. Have a dry rag handy in the bucket as well to wipe off any drips or feather/blend as needed.

- If you run out of touchup oil for cuts/rips/notches and do not have time for us to send more, locally-sourced oil works just fine as well. It might need to be custom-pigmented to match, easily accomplished by the paint store or installer with universal pigment (example Cal-Tint Lamp Black). If unsure what brand or formula to use in a pinch, for end-cuts and rips a low-VOC traditional oil will always work just fine.

## 7. **Other General**

- Soot is bonded into the prefinished plank faces, but the installers will get some soot on their hands and tools from the plank backsides and from cutting. Consciously refrain from nose rubbing during installation, and blow tools down with compressed air outdoors at the end of the day. After installation wipe down the wall with a moist cloth or hose it down (never pressure wash) to remove any soot that made its way to the face via the installers' hands.
- Our products are made from natural materials and will therefore have some variation in color, grain, knot patterns, and sheen board to board. If desired the installer can high-grade planks located near more visible sections (curb elevation, owner's deck, entry doors) and low-grade less visible areas (building side elevations adjacent to neighbors, upper floor sections). Additionally, boards can be graded by tone and placed intentionally for more even color pattern appearance. The owner won't generally notice that this extra effort was taken, but if not done by the contractor the owner may notice and comment on it.
- A tip for value engineering siding cost on projects where a JOKO clear grade façade is desired is to purchase JOKO clear grade wood for more cosmetic elevations and standard select grade wood for less visible sections.
- We recommend using a sharp ultra-fine finishing carbide-tipped saw blade for cutting our products. The yakisugi "shou sugi ban" cypress cuts, rips, and installs the same as standard wood siding, and our millwork produces extremely straight and consistent plank stock. Every stick of wood we ship is within grade.
- Do not field-burn end cuts, rips, or notches. It will blemish the wood and you will regret it. Instead all field cuts should be painted with touchup oil we supply or matched oil sourced locally.
- Extruded or bent aluminum profiles may have better longevity than resin or steel accessories.
- When installing Suyaki it can be difficult to see marks and layout on the textured faces, especially in full sun. Try using a paint pen or grease pencil with contrasting color, or cut a small notch with a utility knife to make your mark.
- Suyaki with exterior grade prefinish is easily blemished, and should not be dragged across the cut station face-down or handled roughly otherwise. When tweaking the boards into place while nailing, be careful not to apply too much pressure with your holding hand as it can tear off the soot layer. Use pressure spread over your entire palm and not just your thumb or fingers. Blemishes will always happen and are the nature of the product. They should be embraced. After installation go over the entire cladding scope with touchup oil to blend and seal handling blemishes.
- At the very end of an installation use the longer remaining board stock where longer boards are needed, and install sections where short pieces can be used very last. The reason is that if you come up short at the end it is much cheaper to ship a few extra boards cut down and shipped with



# NAKAMOTO FORESTRY

standard package ground service (max 9'L) than common carrier. If we have to ship you full length sticks the freight total will be minimum \$1k, including our crating fee, a trucker extreme configurations fee, and if applicable a trucker residential delivery fee.

- Always do stucco or other messy façade sections before installing our sections of wood siding. The reason is that masonry by nature is very dirty work and your stucco subcontractor will always get some overspray or splashed chud on adjacent walls. Softwood siding is very porous and will absorb cement-laden water, leaving a cloudy spot on the siding.
- Do not let your tile sub or landscaper do dirty work nearby as it can get the siding very dirty and difficult to clean. For example, ceramic tile cutting overspray is almost impossible to remove from dark porous softwood siding. Make sure the tile cut station is away from the house.
- Never ever ever ever power wash any kind of wood siding, including ours, whether old or new. Water pressure will damage wood on the cellular level by breaking the cell walls, resulting in accelerated weathering and the need for re-oiling more often.
- If grouting our siding with caulk please make sure to mask off both wet edges to get a clean, narrow, and straight caulk line.
- Use a drying-type, color-matched, and high-grade urethane-modified caulk with high elasticity and adhesion.
- Note that caulking will have a different sheen and color than our siding, so do not caulk nail heads or anything else that will stand out. Caulking and siding will weather in color at different rates, so any caulking will stand out more and more over time.
- Caulking should not be necessary in most cases, and exterior wood siding has been installed without it for millennia. Caulking can cause premature wood rot if sealing a specific gap restricts air flow. Please plan out your caulking details intentionally since caulking often causes siding rot. Stated simply, traditional stain-grade wood siding does not need any caulking if detailed correctly.
- Never caulk horizontal gaps since they act as a weep or vent.
- Glue is rarely used on exterior yakisugi “shou sugi ban”, since eventually any kind of glue will fail before the wood’s lifetime runs out. Some contractors install siding glued to the furring bed with tube adhesive, but this is unnecessary and not a replacement for proper fastener schedule.
- Order slightly more wood than you need and don’t get upset with us if you didn’t order enough. This generally means ordering 5% more overage than if you were purchasing from a local lumber yard. Leftover siding can be used as ko-ushi to screen fixtures such as condensers or trash cans.
- Start the siding installation on a side or back elevation to get accustomed to the siding and substrate before starting on more visible areas such as curb-side elevation or adjacent to a high-traffic location such as owner’s deck.
- Exterior siding is generally installed to exterior tolerances and owners should not expect the same tight joints or other precision detail as with interior grade. Exterior grade wood will move and tolerances must be large enough to allow it to move seasonally.
- Exterior siding installation is often executed in very challenging conditions such as at dangerous heights or in extreme weather. Avoid design details or specifications that will force the contractor to work up hill.



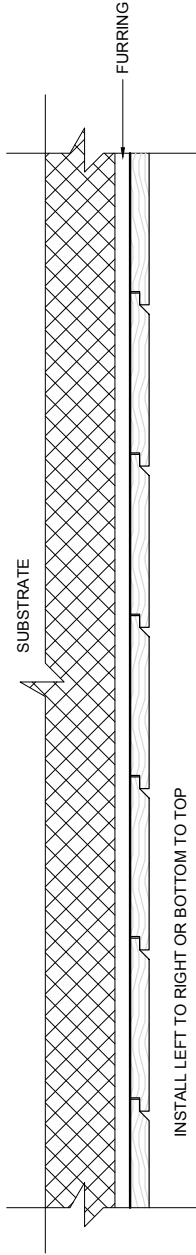

**A** SHIPLAP (VERTICAL OR HORIZONTAL)

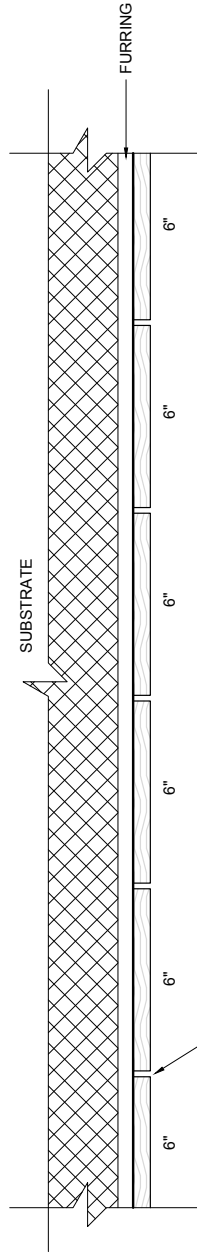

**B** 6" OPEN SCREEN, 6" S3S

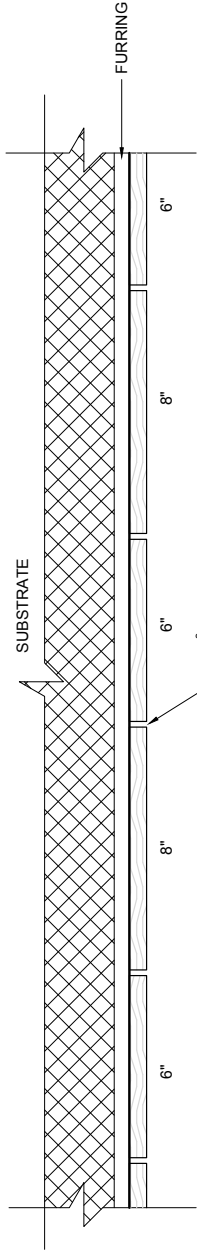

**C** 6" & 8" OPEN SCREEN, 6" & 8" S3S

**GENERAL NOTES:**

1. RECOMMENDED PANEL DETAIL EXAMPLES MUST BE ADAPTED FOR VERTICAL AND OTHER INSTALL LAYOUTS. FURRING AND HEADED FACE NAILS REQUIRED FOR ALL EXTERIOR INSTALLATIONS.
2. VERIFY ALL DIMENSIONS AND ELEVATIONS.
3. THESE DETAILS ARE NOT FOR CONSTRUCTION.
4. NAKAMOTO FORESTRY TAKES NO RESPONSIBILITY FOR THE DESIGN AND CONSTRUCTION OF CUSTOMER PROJECTS. THESE DRAWINGS ARE FOR EXAMPLE REFERENCE ONLY.

**NOT FOR CONSTRUCTION**



Tel: +1-503-512-6780  
 Fax: +1-503-828-9665  
 Email: info@nakamotoforestry.com  
 Warehouse & Office - (by Appt. ONLY)  
 6400 SE 101st Ave Unit 2C  
 Portland OR 97266

Project Title:  
**SIDING & PANELING  
 LAYOUT SUGGESTIONS**

No.	Revision Date	Description
#2	12/02/2019	Beleck Rev.

Project No.	000-000
Drawn By:	PLM
Date:	11/20/2019
Drawing No.	<b>N1.10</b>

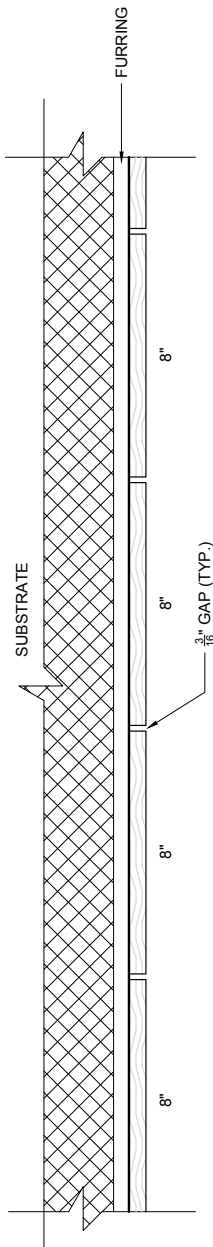

NOTE: BE SURE TO HAVE A BLACK SUBSTRATE

**(A)** 8" OPEN SCREEN, 8" S3S

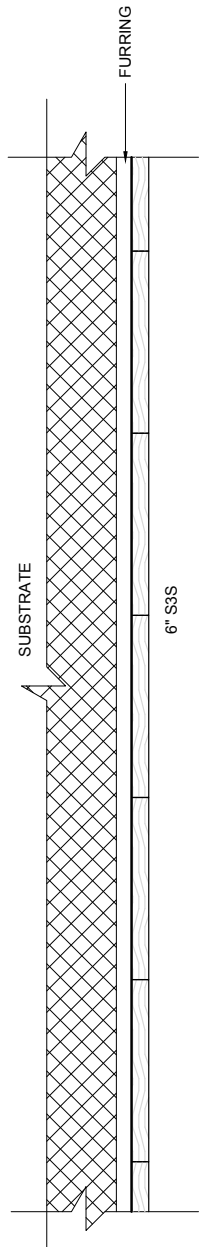

**(B)** 6" CLOSED SCREEN, 6" S3S

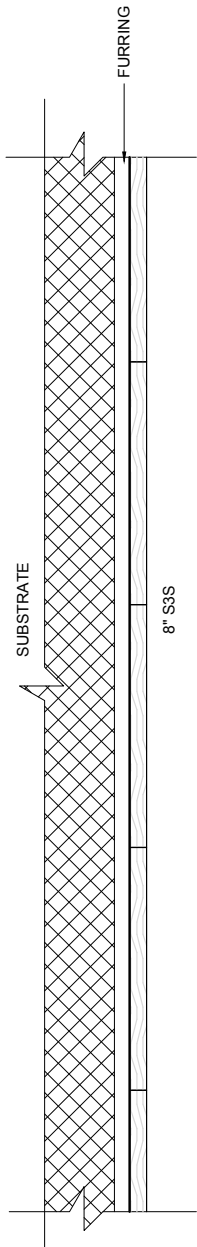

**(C)** 8" CLOSED SCREEN, 8" S3S

**GENERAL NOTES:**

1. RECOMMENDED PANEL DETAIL EXAMPLES MUST BE ADAPTED FOR VERTICAL AND OTHER INSTALL LAYOUTS. FURRING AND HEADED FACE NAILS REQUIRED FOR ALL EXTERIOR INSTALLATIONS.
2. VERIFY ALL DIMENSIONS AND ELEVATIONS.
3. THESE DETAILS ARE NOT FOR CONSTRUCTION.
4. NAKAMOTO FORESTRY TAKES NO RESPONSIBILITY FOR THE DESIGN AND CONSTRUCTION OF CUSTOMER PROJECTS. THESE DRAWINGS ARE FOR EXAMPLE REFERENCE ONLY.

**NOT FOR CONSTRUCTION**



**NAKAMOTO FORESTRY**

Tel: +1-503-512-6780  
 Fax: +1-503-828-9665  
 Email: info@nakamotoforestry.com  
 Warehouse & Office - (by Appt. ONLY)  
 6400 SE 101st Ave Unit 2C  
 Portland OR 97266

Project Title:  
**SIDING & PANELING  
 LAYOUT SUGGESTIONS**

No.	Revision Date	Description
#2	12/02/2019	Beleck Rev.

Project No.	000-000
Drawn By:	PLM
Date:	11/20/2019
Drawing No.	<b>N1.11</b>

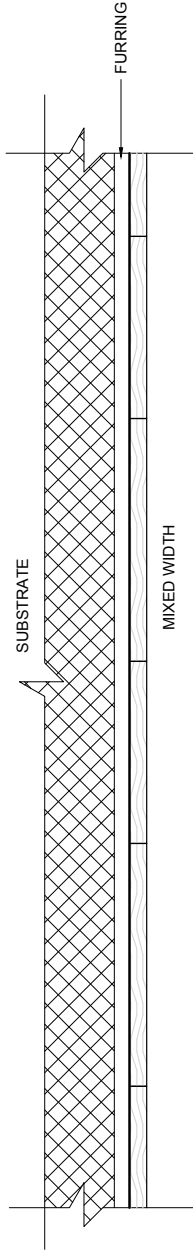

**(A)** 6" & 8" CLOSED SCREEN, 6" & 8" S3S

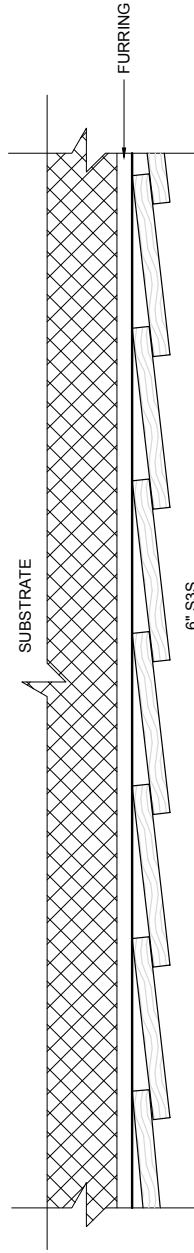

NOTE: OVERLAP MINIMUM 1"

BE AWARE THAT LATERAL CUPPING IS LIKELY WITH THIS LAYOUT

**(B)** 6" VERTICAL OR HORIZONTAL CLAPBOARD

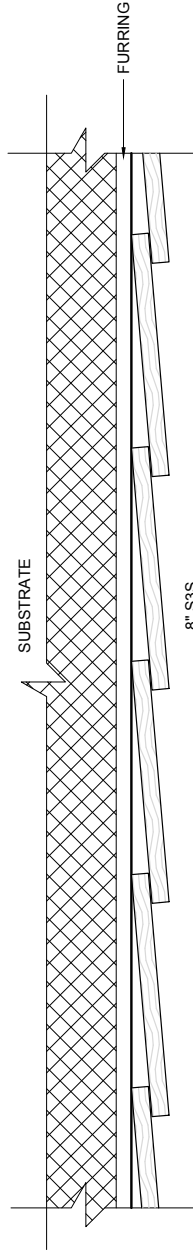

NOTE: OVERLAP MINIMUM 1.5"

BE AWARE THAT LATERAL CUPPING IS LIKELY WITH THIS LAYOUT

**(C)** 8" VERTICAL OR HORIZONTAL CLAPBOARD

**GENERAL NOTES:**

1. RECOMMENDED PANEL DETAIL EXAMPLES MUST BE ADAPTED FOR VERTICAL AND OTHER INSTALL LAYOUTS. FURRING AND HEADED FACE NAILS REQUIRED FOR ALL EXTERIOR INSTALLATIONS.
2. VERIFY ALL DIMENSIONS AND ELEVATIONS.
3. THESE DETAILS ARE NOT FOR CONSTRUCTION. NAKAMOTO FORESTRY TAKES NO RESPONSIBILITY FOR THE DESIGN AND CONSTRUCTION OF CUSTOMER PROJECTS. THESE DRAWINGS ARE FOR EXAMPLE REFERENCE ONLY.

**NOT FOR CONSTRUCTION**



**NAKAMOTO FORESTRY**

Tel: +1-503-512-6780  
 Fax: +1-503-828-9665  
 Email: info@nakamotoforestry.com  
 Warehouse & Office - (by Appt. ONLY)  
 6400 SE 101st Ave Unit 2C  
 Portland OR 97266

Project Title:  
**SIDING & PANELING  
 LAYOUT SUGGESTIONS**

No.	Revision Date	Description
#3	02/18/2020	Beleck Rev.

Project No.	000-000
Drawn By:	PLM
Date:	11/20/2019
Drawing No.	<b>N1.12</b>

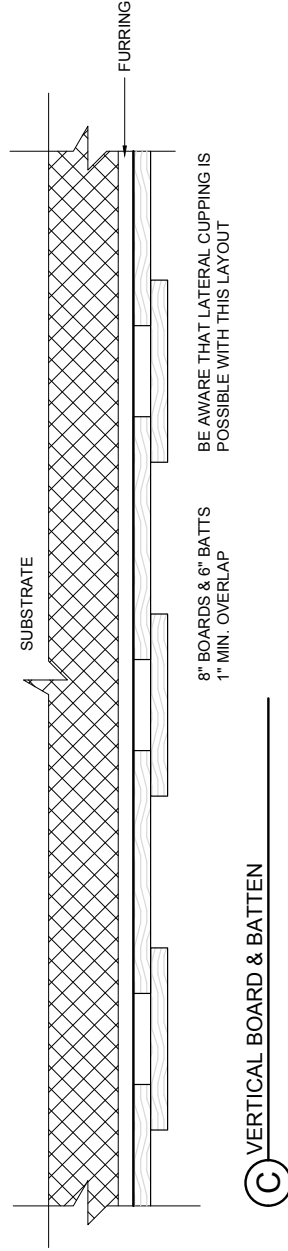
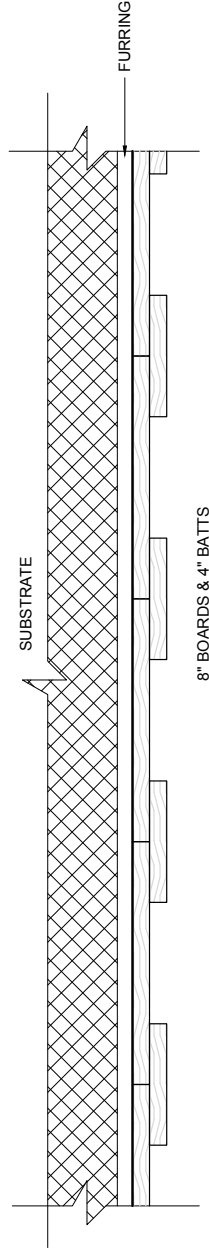
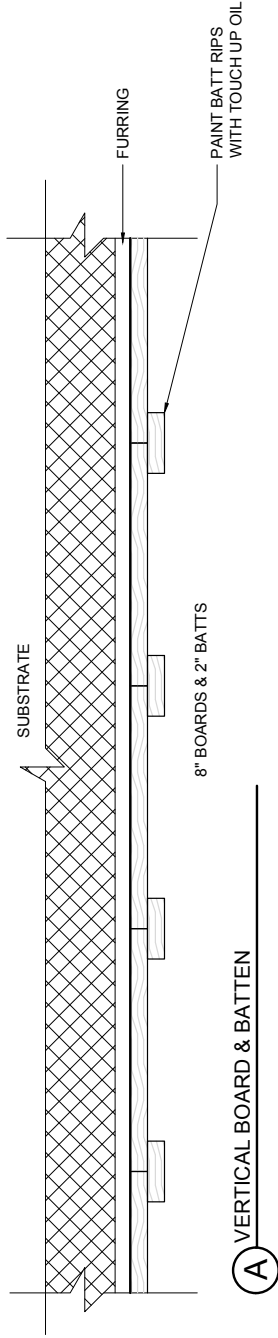

**GENERAL NOTES:**

1. RECOMMENDED PANEL DETAIL EXAMPLES MUST BE ADAPTED FOR VERTICAL AND OTHER INSTALL LAYOUTS. FURRING AND HEADED FACE NAILS REQUIRED FOR ALL EXTERIOR INSTALLATIONS.
2. VERIFY ALL DIMENSIONS AND ELEVATIONS.
3. THESE DETAILS ARE NOT FOR CONSTRUCTION.
4. NAKAMOTO FORESTRY TAKES NO RESPONSIBILITY FOR THE DESIGN AND CONSTRUCTION OF CUSTOMER PROJECTS. THESE DRAWINGS ARE FOR EXAMPLE REFERENCE ONLY.

**NOT FOR CONSTRUCTION**



**NAKAMOTO FORESTRY**

Tel: +1-503-512-6780  
 Fax: +1-503-828-9665  
 Email: info@nakamotoforestry.com  
 Warehouse & Office - (by Appt. ONLY)  
 6400 SE 101st Ave Unit 2C  
 Portland OR 97266

Project Title:  
**SIDING & PANELING LAYOUT SUGGESTIONS**

Project No. 000-000  
 Drawn By: PLM  
 Date: 11/20/2019  
 Drawing No. **N1.13**

No.	Revision Date	Description
#3	02/20/2020	Beleck Rev.

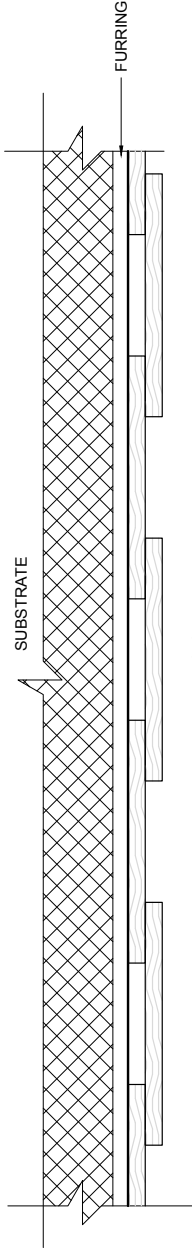

BE AWARE THAT LATERAL CUPPING IS POSSIBLE WITH THIS LAYOUT

8" S3S  
8" BOARDS & 8" BATTS  
1.5" MINIMUM OVERLAP

**(A)** VERTICAL BOARD & BATTEN

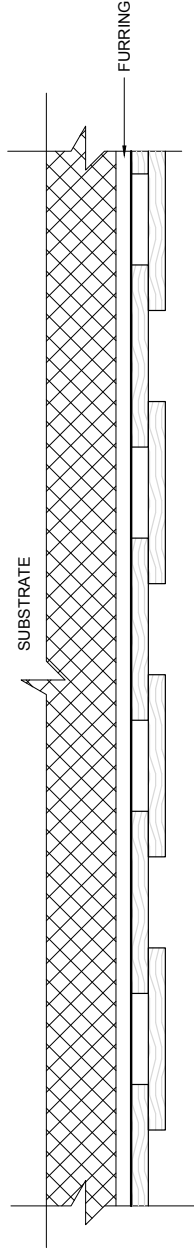

BE AWARE THAT LATERAL CUPPING IS POSSIBLE WITH THIS LAYOUT

6" S3S  
6" BOARDS & 6" BATTS  
1" MIN. OVERLAP

**(B)** VERTICAL BOARD & BATTEN

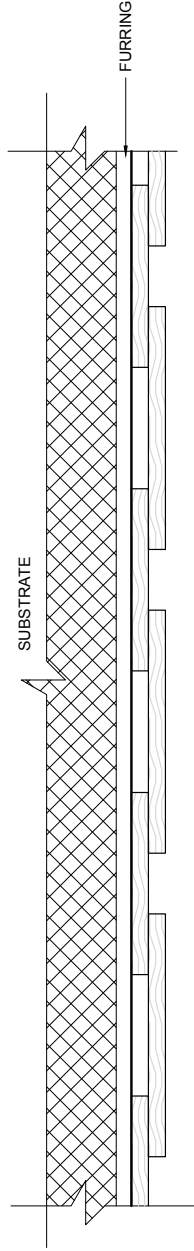

BE AWARE THAT LATERAL CUPPING IS POSSIBLE WITH THIS LAYOUT

6" & 8" S3S  
6" BOARDS & 8" BATTS  
1.5" MIN. OVERLAP

**(C)** VERTICAL REVERSE BOARD & BATTEN

**GENERAL NOTES:**

1. RECOMMENDED PANEL DETAIL EXAMPLES MUST BE ADAPTED FOR VERTICAL AND OTHER INSTALL LAYOUTS, FURRING AND HEADED FACE NAILS REQUIRED FOR ALL EXTERIOR INSTALLATIONS.
2. VERIFY ALL DIMENSIONS AND ELEVATIONS.
3. THESE DETAILS ARE NOT FOR CONSTRUCTION.
4. NAKAMOTO FORESTRY TAKES NO RESPONSIBILITY FOR THE DESIGN AND CONSTRUCTION OF CUSTOMER PROJECTS. THESE DRAWINGS ARE FOR EXAMPLE REFERENCE ONLY.

**NOT FOR CONSTRUCTION**



**NAKAMOTO FORESTRY**

Tel: +1-503-512-6780  
Fax: +1-503-828-9665  
Email: [info@nakamotoforestry.com](mailto:info@nakamotoforestry.com)  
Warehouse & Office - (by Appt. ONLY)  
6400 SE 101st Ave Unit 2C  
Portland OR 97266

Project Title:  
**SIDING & PANELING  
LAYOUT SUGGESTIONS**

No.	Revision Date	Description
#4	02/20/2020	Beleck Rev.

Project No.	000-000
Drawn By:	PLM
Date:	11/20/2019
Drawing No.	<b>N1.14</b>

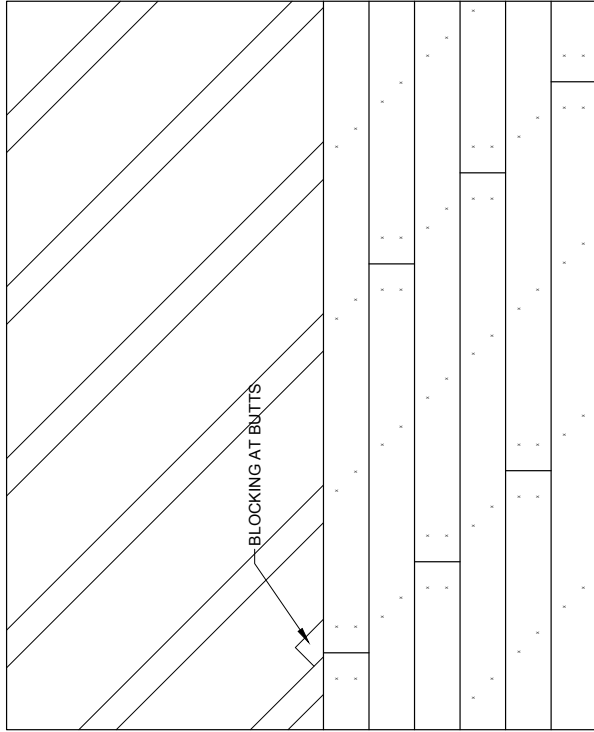

DIAGONAL FURRING  
VENTED TOP, BOTTOM,  
CORNERS, AND PENETRATIONS

**(A)** RAIN SCREEN FURRING LAYOUT SUGGESTIONS

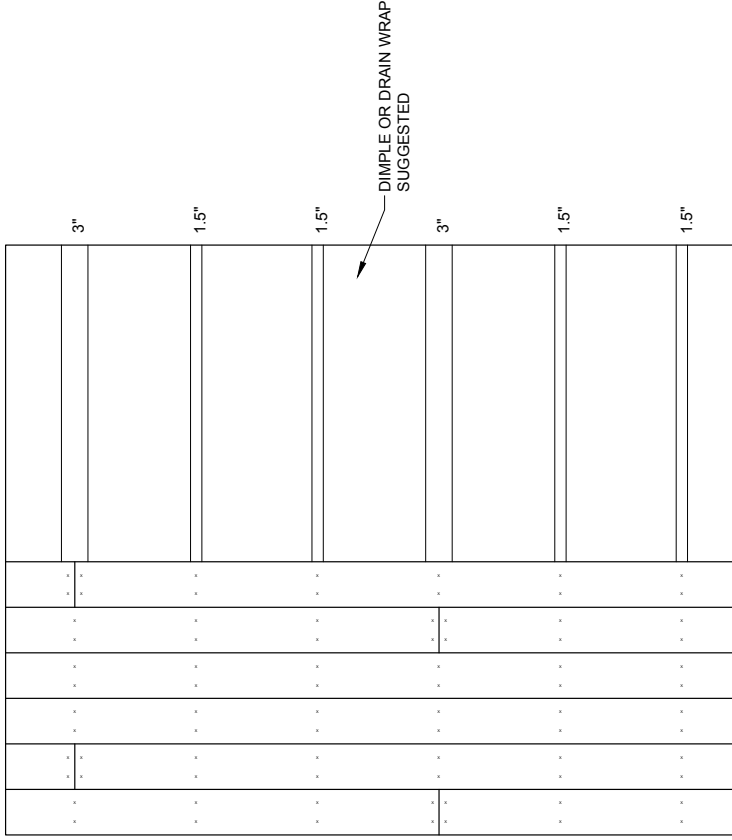

VERTICAL FURRING  
3" MINIMUM FURRING WIDTH  
FOR BUTTS  
1.5" MINIMUM FURRING WIDTH  
FOR INTERMEDIATE STRIPPING  
VENTED OUT CORNERS AND  
PENETRATIONS

**(B)** SIDING & PANELING LAYOUT SUGGESTIONS

**GENERAL NOTES:**

1. RECOMMENDED PANEL DETAIL EXAMPLES MUST BE ADAPTED FOR VERTICAL AND OTHER INSTALL LAYOUTS, FURRING AND HEADED FACE NAILS REQUIRED FOR ALL EXTERIOR INSTALLATIONS.
2. VERIFY ALL DIMENSIONS AND ELEVATIONS.
3. THESE DETAILS ARE NOT FOR CONSTRUCTION.
4. NAKAMOTO FORESTRY TAKES NO RESPONSIBILITY FOR THE DESIGN AND CONSTRUCTION OF CUSTOMER PROJECTS. THESE DRAWINGS ARE FOR EXAMPLE REFERENCE ONLY.

**NOT FOR CONSTRUCTION**



**NAKAMOTO  
FORESTRY**

Tel: +1-503-512-6780  
Fax: +1-503-828-9685  
Email: [info@nakamotoforestry.com](mailto:info@nakamotoforestry.com)  
Warehouse & Office - (by Appt. ONLY)  
6400 SE 101st Ave Unit 2C  
Portland OR 97266

Project Title: <b>RAIN SCREEN FURRING LAYOUT SUGGESTIONS</b>		Project No.: 000-000
No. Revision Date		Drawn By: PLM
#2 12/02/2019		Date: 11/20/2019
Description		Drawing No.
Beleck Rev.		<b>N1.15</b>



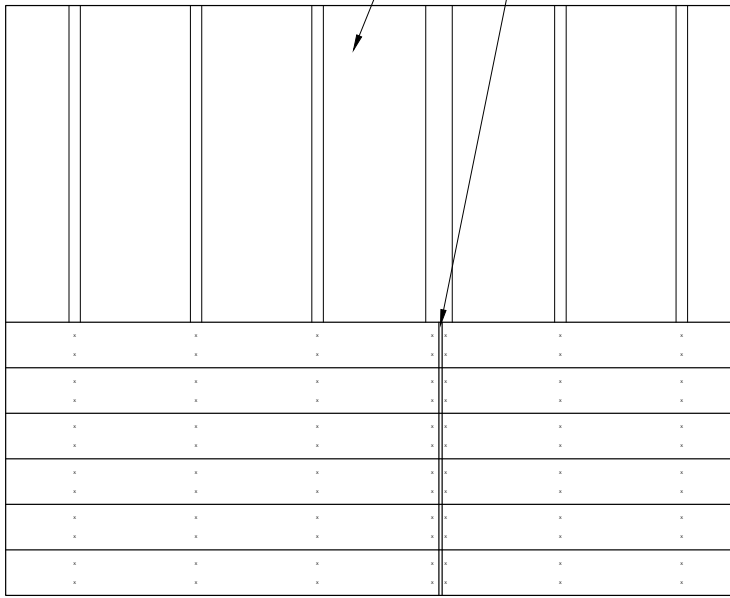

VERTICAL FURRING  
 3" MINIMUM FURRING WIDTH  
 FOR BUTTS  
 1.5" MINIMUM FURRING WIDTH  
 FOR INTERMEDIATE STRIPPING  
 VENTED OUT CORNERS AND  
 PENETRATIONS  
 PLEASE USE Z-BAR AT BOND  
 LINES

**A** SIDING & PANELING LAYOUT SUGGESTIONS

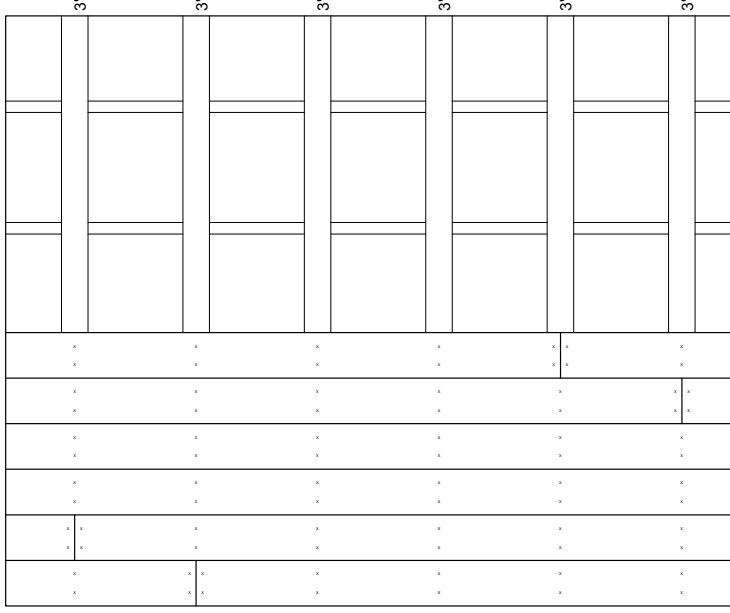

GRID FURRING (REQUIRED BY  
 SOME MUNICIPALITIES)

**B** SIDING & PANELING LAYOUT SUGGESTIONS

GENERAL NOTES:

1. RECOMMENDED PANEL DETAIL EXAMPLES MUST BE ADAPTED FOR VERTICAL AND OTHER INSTALL LAYOUTS. FURRING AND HEADED FACE NAILS REQUIRED FOR ALL EXTERIOR INSTALLATIONS.
2. VERIFY ALL DIMENSIONS AND ELEVATIONS.
3. THESE DETAILS ARE NOT FOR CONSTRUCTION. NAKAMOTO FORESTRY TAKES NO RESPONSIBILITY FOR THE DESIGN AND CONSTRUCTION OF CUSTOMER PROJECTS. THESE DRAWINGS ARE FOR EXAMPLE REFERENCE ONLY.

NOT FOR CONSTRUCTION



**NAKAMOTO FORESTRY**

Tel: +1-503-512-6780  
 Fax: +1-503-828-9665  
 Email: info@nakamotoforestry.com  
 Warehouse & Office - (by Appt. ONLY)  
 6400 SE 101st Ave Unit 2C  
 Portland OR 97266

Project Title:	RAIN SCREEN FURRING LAYOUT SUGGESTIONS	
Project No.:	000-000	
Drawn By:	PLM	
Date:	11/20/2019	
Drawing No.:	N1.16	
No.:	Revision Date	Description
#2	12/02/2019	Beleck Rev.

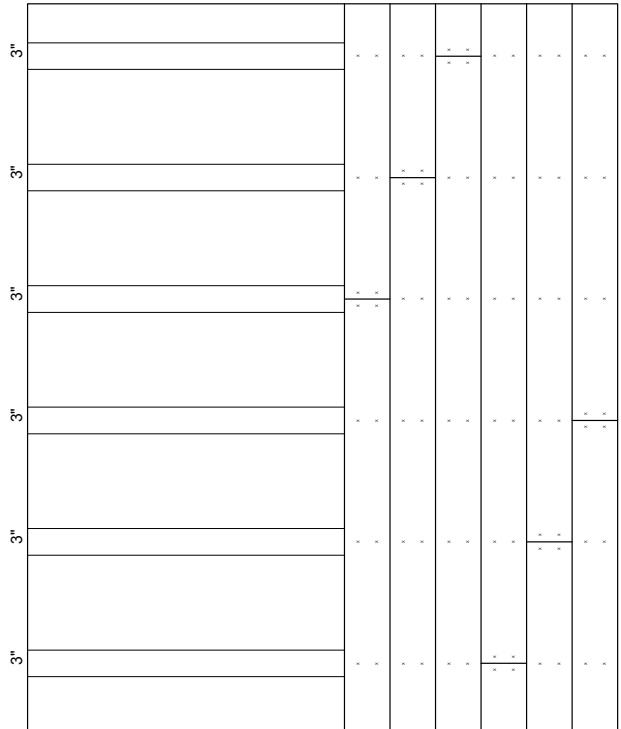

VERTICAL FURRING  
3" MINIMUM FURRING WITH  
STAGGERED BUTTS

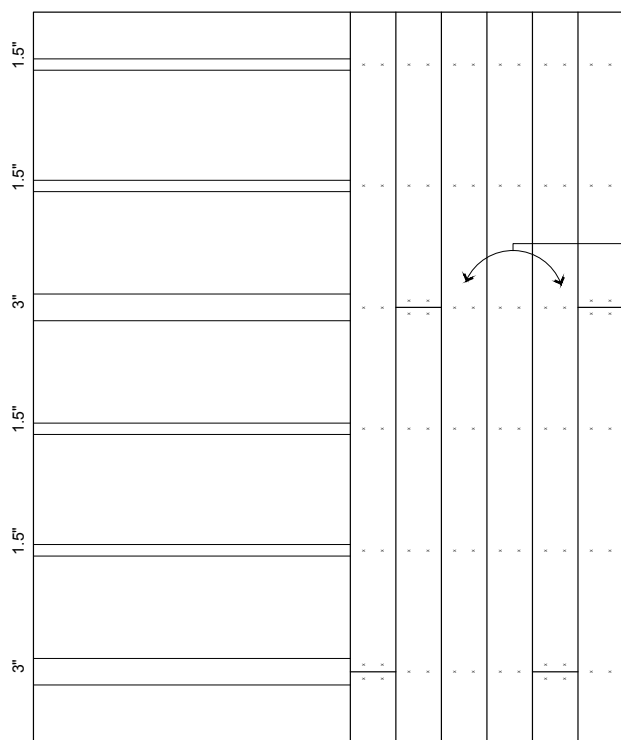

VERTICAL FURRING  
3" MINIMUM FURRING WIDTH  
FOR BUTTS  
1.5" MINIMUM FURRING WIDTH  
FOR INTERMEDIATE STRIPPING

MINIMUM 2 UNBROKEN ROWS  
BETWEEN BUTTS FOR BEST  
APPEARANCE

**(A)** SIDING & PANELING LAYOUT SUGGESTIONS

**(B)** RAIN SCREEN FURRING LAYOUT SUGGESTIONS

**GENERAL NOTES:**

1. RECOMMENDED PANEL DETAIL EXAMPLES MUST BE ADAPTED FOR VERTICAL AND OTHER INSTALL LAYOUTS. FURRING AND HEADED FACE NAILS REQUIRED FOR ALL EXTERIOR INSTALLATIONS.
2. VERIFY ALL DIMENSIONS AND ELEVATIONS.
3. THESE DETAILS ARE NOT FOR CONSTRUCTION.
4. NAKAMOTO FORESTRY TAKES NO RESPONSIBILITY FOR THE DESIGN AND CONSTRUCTION OF CUSTOMER PROJECTS. THESE DRAWINGS ARE FOR EXAMPLE REFERENCE ONLY.

**NOT FOR CONSTRUCTION**



**NAKAMOTO FORESTRY**

Tel: +1-503-512-6780  
Fax: +1-503-828-9665  
Email: info@nakamotoforestry.com  
Warehouse & Office - (by Appt. ONLY)  
6400 SE 101st Ave Unit 2C  
Portland OR 97266

Project Title: <b>RAIN SCREEN FURRING LAYOUT SUGGESTIONS</b>		Project No.: 000-000
No. Revision Date		Drawn By: PLM
#3 02/18/2020		Date: 11/20/2019
Description		Drawing No.
Beleck Rev.		<b>N1.17</b>

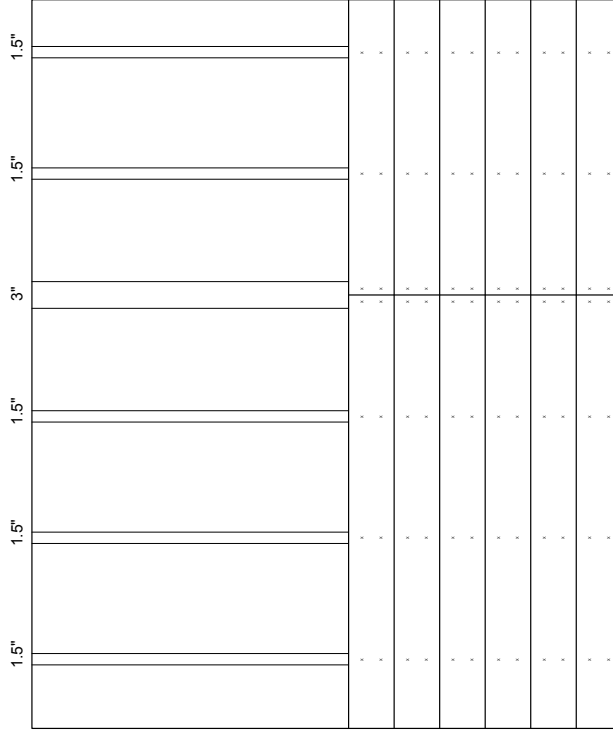

VERTICAL FURRING  
 3" MINIMUM FURRING WIDTH  
 FOR BUTTS  
 1.5" MINIMUM FURRING WIDTH  
 FOR INTERMEDIATE STRIPPING  
 STRAIGHT BOND LINE

**A** SIDING & PANELING LAYOUT SUGGESTIONS

GENERAL NOTES:

1. RECOMMENDED PANEL DETAIL EXAMPLES MUST BE ADAPTED FOR VERTICAL AND OTHER INSTALL LAYOUTS. FURRING AND HEADED FACE NAILS REQUIRED FOR ALL EXTERIOR INSTALLATIONS.
2. VERIFY ALL DIMENSIONS AND ELEVATIONS.
3. THESE DETAILS ARE NOT FOR CONSTRUCTION.
4. NAKAMOTO FORESTRY TAKES NO RESPONSIBILITY FOR THE DESIGN AND CONSTRUCTION OF CUSTOMER PROJECTS. THESE DRAWINGS ARE FOR EXAMPLE REFERENCE ONLY.

**NOT FOR CONSTRUCTION**



**NAKAMOTO FORESTRY**

Tel. +1-503-512-6780  
 Fax +1-503-828-9685  
 Email: info@nakamotoforestry.com  
 Warehouse & Office - (by Appt. ONLY)  
 6400 SE 101st Ave Unit 2C  
 Portland OR 97266

Project Title: <b>RAIN SCREEN FURRING LAYOUT SUGGESTIONS</b>		Project No.: 000-000
No. Revision Date		Drawn By: PLM
Description		Date: 11/20/2019
		Drawing No. <b>N1.18</b>

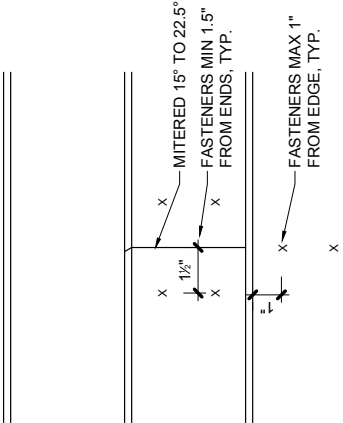

STAGGERED BOND LINES

**(A)** HORIZONTAL LAYOUT SCARF JOINT

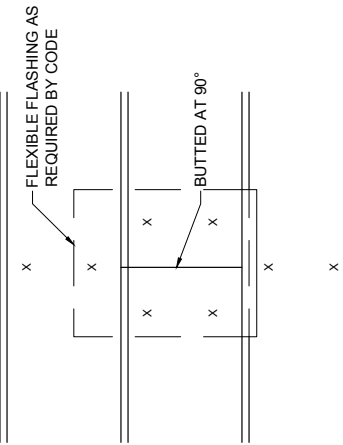

STAGGERED BOND LINES

**(B)** HORIZONTAL LAYOUT BUTT JOINT

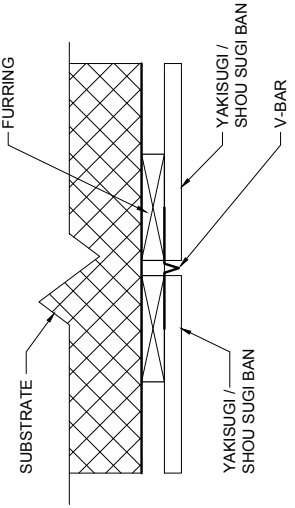

CONSISTENT BOND LINES

**(C)** PLAN VIEW - HORIZONTAL LAYOUT

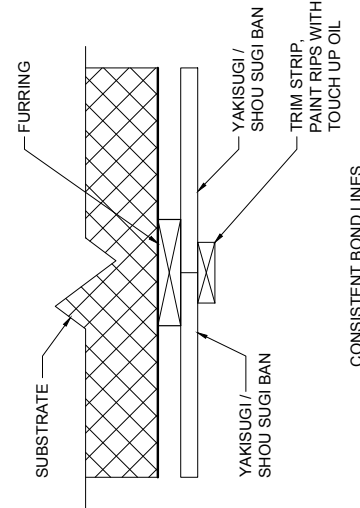

CONSISTENT BOND LINES

**(D)** PLAN VIEW - HORIZONTAL LAYOUT

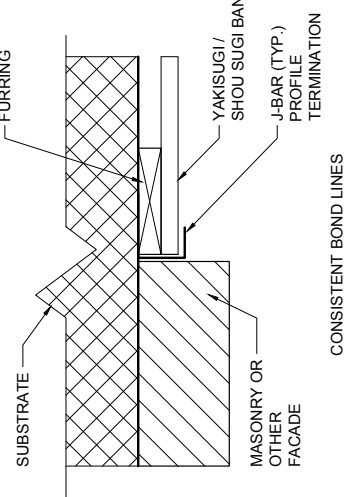

CONSISTENT BOND LINES

**(E)** PLAN VIEW - HORIZONTAL LAYOUT

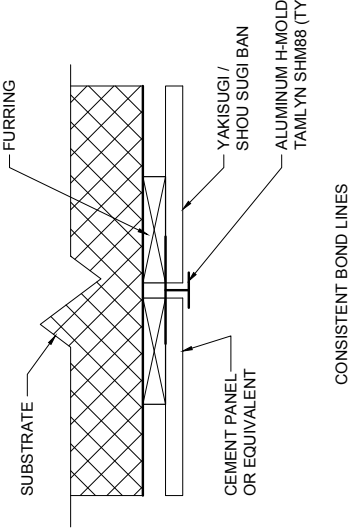

CONSISTENT BOND LINES

**(F)** PLAN VIEW - HORIZONTAL LAYOUT

**GENERAL NOTES:**

1. RECOMMENDED PANEL DETAIL EXAMPLES MUST BE ADAPTED FOR VERTICAL AND OTHER INSTALL LAYOUTS. FURRING AND HEADED FACE NAILS REQUIRED FOR ALL EXTERIOR INSTALLATIONS.
2. VERIFY ALL DIMENSIONS AND ELEVATIONS.
3. THESE DETAILS ARE NOT FOR CONSTRUCTION.
4. NAKAMOTO FORESTRY TAKES NO RESPONSIBILITY FOR THE DESIGN AND CONSTRUCTION OF CUSTOMER PROJECTS. THESE DRAWINGS ARE FOR EXAMPLE REFERENCE ONLY.

**NOT FOR CONSTRUCTION**



**NAKAMOTO FORESTRY**

Tel: +1-503-512-6780  
 Fax: +1-503-828-9685  
 Email: info@nakamotoforestry.com  
 Warehouse & Office - (by Appt. ONLY)  
 6400 SE 101st Ave Unit 2C  
 Portland OR 97266

Project Title:	EXTERIOR BOND LINE DETAIL
No.	#9
Revision Date	02/20/2020
Description	Beleck Rev.
Project No.	000-000
Drawn By:	PLM
Date:	01/09/2020
Drawing No.	<b>N1.02</b>

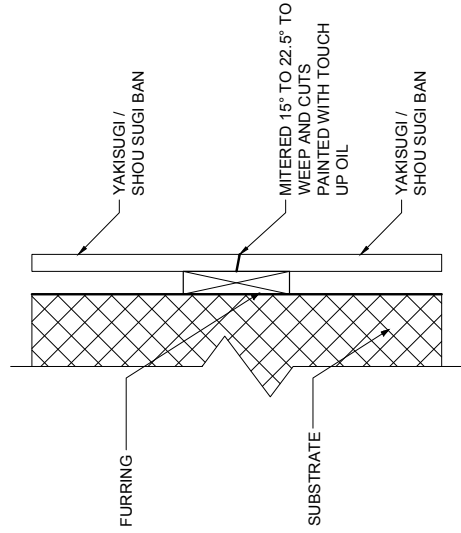

**(A)** VERTICAL LAYOUT SCARF JOINT

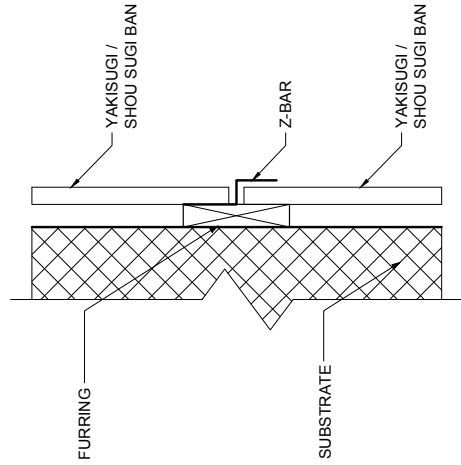

**(B)** VERTICAL LAYOUT BUTT JOINT

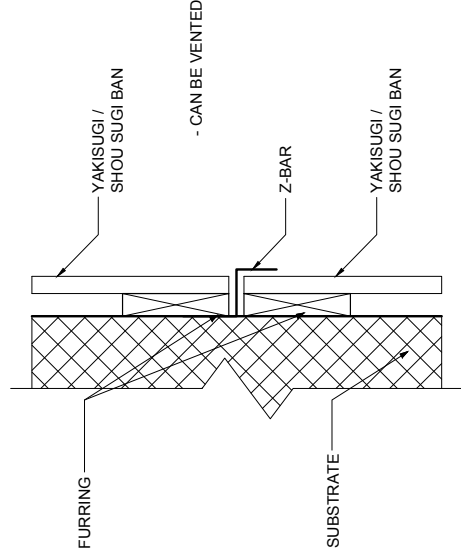

**(C)** VERTICAL LAYOUT BUTT JOINT

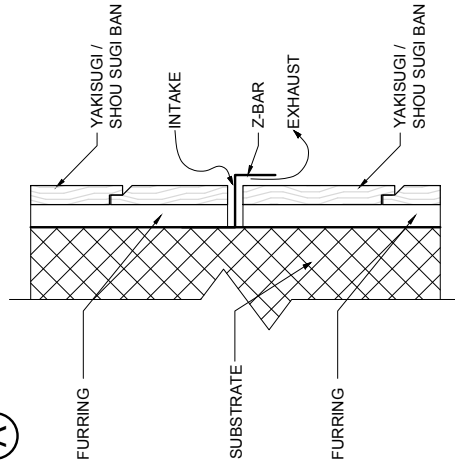

**(D)** HORIZONTAL LAYOUT BOND LINE VENTING

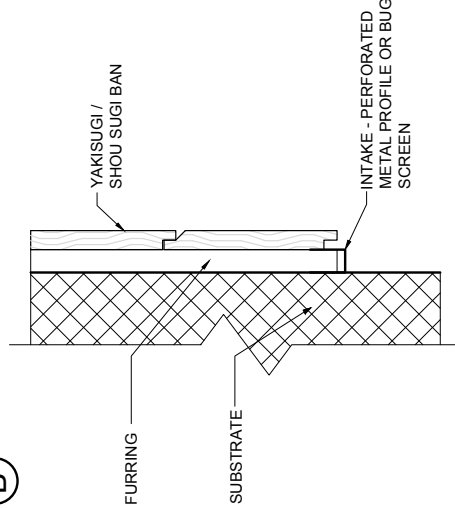

**(E)** HORIZONTAL INSTALL DRIP INTAKE

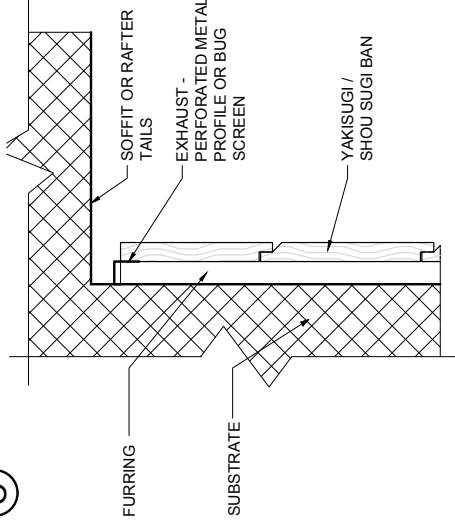

**(F)** VENTING AT SOFFIT OR RAFTER

**GENERAL NOTES:**

1. RECOMMENDED PANEL DETAIL EXAMPLES MUST BE ADAPTED FOR VERTICAL AND OTHER INSTALL LAYOUTS. FURRING AND HEADED FACE NAILS REQUIRED FOR ALL EXTERIOR INSTALLATIONS.
2. VERIFY ALL DIMENSIONS AND ELEVATIONS.
3. THESE DETAILS ARE NOT FOR CONSTRUCTION.
4. NAKAMOTO FORESTRY TAKES NO RESPONSIBILITY FOR THE DESIGN AND CONSTRUCTION OF CUSTOMER PROJECTS. THESE DRAWINGS ARE FOR EXAMPLE REFERENCE ONLY.

**NOT FOR CONSTRUCTION**



**NAKAMOTO FORESTRY**

Tel: +1-503-512-6780  
 Fax: +1-503-828-3665  
 Email: [info@nakamotoforestry.com](mailto:info@nakamotoforestry.com)  
 Warehouse & Office - (by Appt. ONLY)  
 6400 SE 101st Ave Unit 2C  
 Portland OR 97266

Project Title:  
**EXTERIOR BOND LINE  
 DETAIL**

Project No.	000-000
Drawn By:	PLM
Date:	01/09/2020
Drawing No.	<b>N1.01</b>

No.	Revision Date	Description
#9	02/19/2020	Beleck Rev.

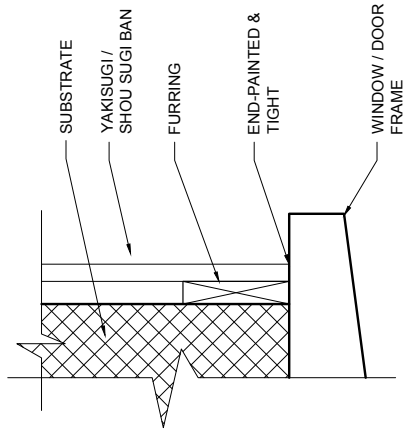

**A** PLAN VIEW - DOOR & WINDOW PENETRATION

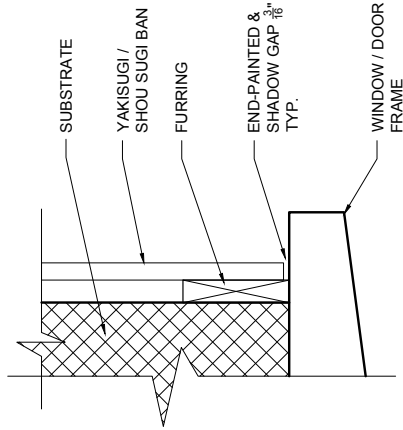

**B** PLAN VIEW - DOOR & WINDOW PENETRATION

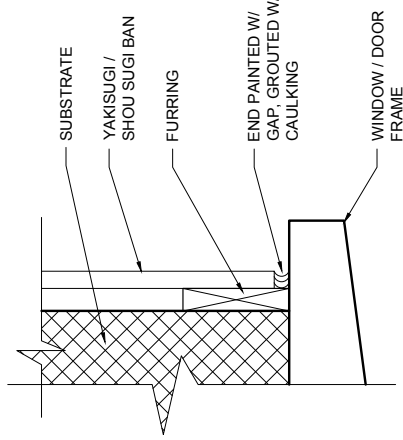

**C** PLAN VIEW - DOOR & WINDOW PENETRATION

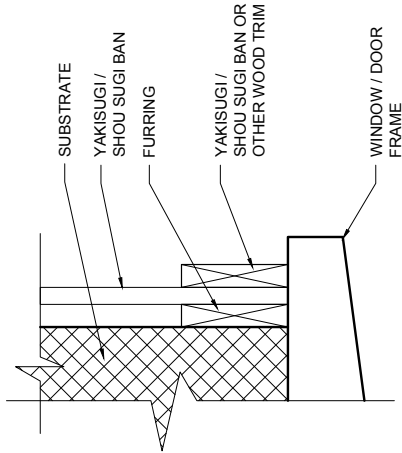

**D** PLAN VIEW - DOOR & WINDOW PENETRATION

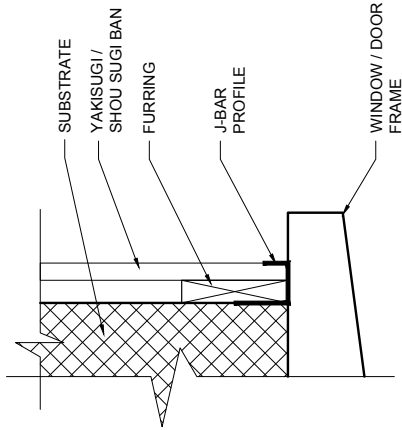

**E** PLAN VIEW - DOOR & WINDOW PENETRATION

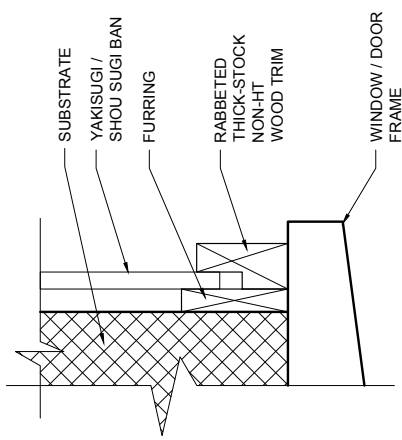

**F** PLAN VIEW - DOOR & WINDOW PENETRATION

**GENERAL NOTES:**

1. RECOMMENDED PANEL DETAIL EXAMPLES MUST BE ADAPTED FOR VERTICAL AND OTHER INSTALL LAYOUTS. FURRING AND HEADED FACE NAILS REQUIRED FOR ALL EXTERIOR INSTALLATIONS.
2. VERIFY ALL DIMENSIONS AND ELEVATIONS.
3. THESE DETAILS ARE NOT FOR CONSTRUCTION.
4. NAKAMOTO FORESTRY TAKES NO RESPONSIBILITY FOR THE DESIGN AND CONSTRUCTION OF CUSTOMER PROJECTS. THESE DRAWINGS ARE FOR EXAMPLE REFERENCE ONLY.

**NOT FOR CONSTRUCTION**



**NAKAMOTO FORESTRY**

Tel: +1-503-512-6780  
 Fax: +1-503-828-9665  
 Email: [info@nakamotoforestry.com](mailto:info@nakamotoforestry.com)  
 Warehouse & Office - (by Appt. ONLY)  
 6400 SE 101st Ave Unit 2C  
 Portland OR 97266

Project Title:  
**DOOR & WINDOW PENETRATION SUGGESTIONS - 1 OF 2 SHEETS**

No. Revision Date Description  
**#2 12/02/2019 Beleck Rev.**

Project No. 000-000  
 Drawn By: PLM  
 Date: 11/20/2019  
 Drawing No. **N1.05**

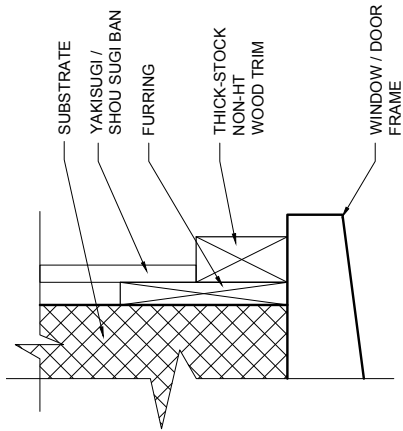

**A** PLAN VIEW - DOOR & WINDOW PENETRATION

GENERAL NOTES:

1. RECOMMENDED PANEL DETAIL EXAMPLES MUST BE ADAPTED FOR VERTICAL AND OTHER INSTALL LAYOUTS. FURRING AND HEADED FACE NAILS REQUIRED FOR ALL EXTERIOR INSTALLATIONS.
2. VERIFY ALL DIMENSIONS AND ELEVATIONS.
3. THESE DETAILS ARE NOT FOR CONSTRUCTION.
4. NAKAMOTO FORESTRY TAKES NO RESPONSIBILITY FOR THE DESIGN AND CONSTRUCTION OF CUSTOMER PROJECTS. THESE DRAWINGS ARE FOR EXAMPLE REFERENCE ONLY.

**NOT FOR CONSTRUCTION**



**NAKAMOTO  
FORESTRY**

Tel: +1-503-512-6780  
 Fax: +1-503-828-9685  
 Email: [info@nakamotoforestry.com](mailto:info@nakamotoforestry.com)  
 Warehouse & Office - (by Appt. ONLY)  
 6400 SE 101st Ave Unit 2C  
 Portland OR 97266

Project Title:

**DOOR & WINDOW PENETRATION  
SUGGESTIONS - 2 OF 2 SHEETS**

Project No. 000-000

Drawn By: PLM

Date: 11/20/2019

Drawing No.

**N1.06**

No. Revision Date Description

#3 12/02/2019 Beleck Rev.

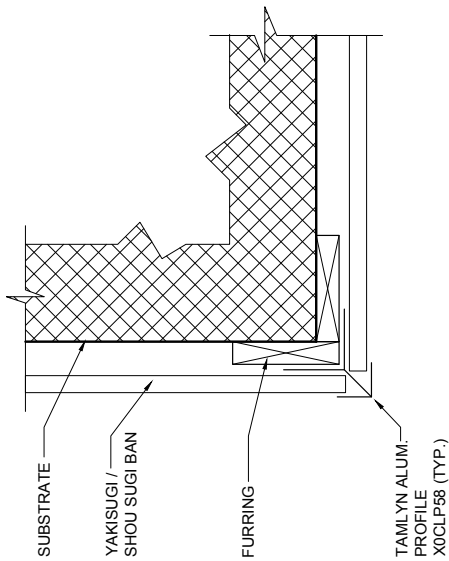

**A** PLAN VIEW - OUTSIDE CORNER - METAL

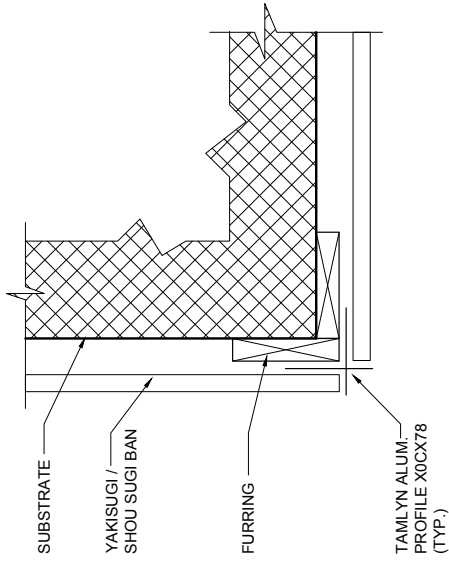

**B** PLAN VIEW - OUTSIDE CORNER - METAL

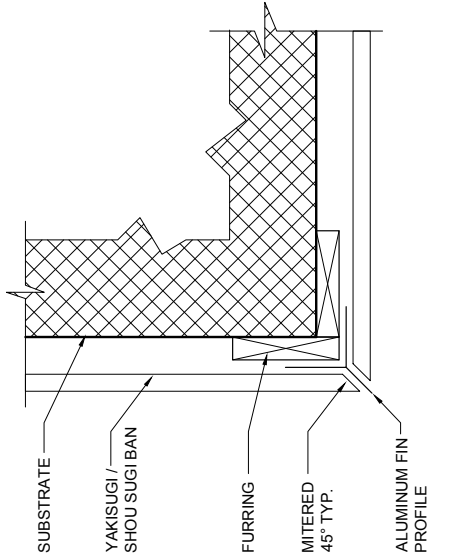

**C** PLAN VIEW - OUTSIDE CORNER - METAL

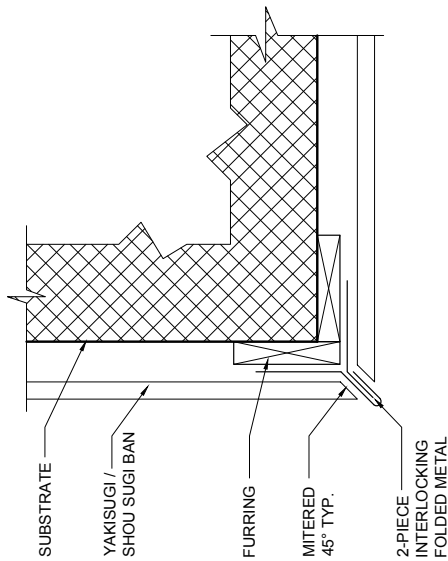

**D** PLAN VIEW - OUTSIDE CORNER - METAL

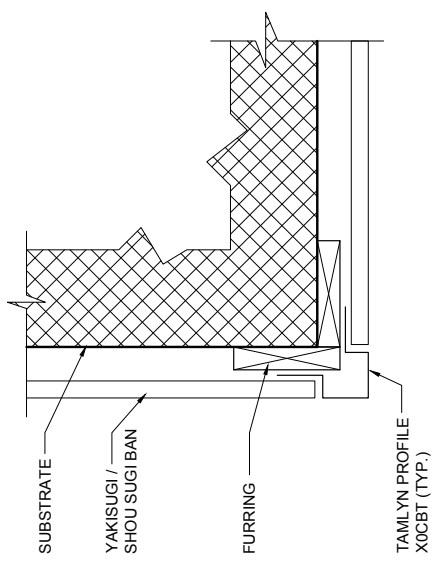

**E** PLAN VIEW - OUTSIDE CORNER - METAL

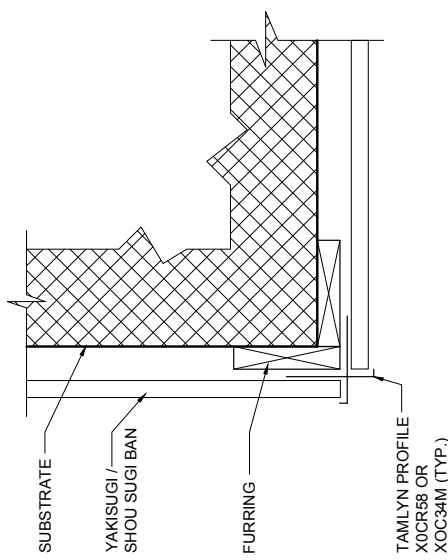

**F** PLAN VIEW - OUTSIDE CORNER - METAL

**GENERAL NOTES:**

1. RECOMMENDED PANEL DETAIL EXAMPLES MUST BE ADAPTED FOR VERTICAL AND OTHER INSTALL LAYOUTS. FURRING AND HEADED FACE NAILS REQUIRED FOR ALL EXTERIOR INSTALLATIONS.
2. VERIFY ALL DIMENSIONS AND ELEVATIONS.
3. THESE DETAILS ARE NOT FOR CONSTRUCTION.
4. NAKAMOTO FORESTRY TAKES NO RESPONSIBILITY FOR THE DESIGN AND CONSTRUCTION OF CUSTOMER PROJECTS. THESE DRAWINGS ARE FOR EXAMPLE REFERENCE ONLY.

**NOT FOR CONSTRUCTION**



**NAKAMOTO FORESTRY**

Tel. +1-503-512-6780  
 Fax +1-503-828-9685  
 Email: info@nakamotoforestry.com  
 Warehouse & Office - (by Appt. ONLY)  
 6400 SE 101st Ave Unit 2C  
 Portland OR 97266

Project Title:	Project No. 000-000
EXTERIOR OUTSIDE CORNER ALUMINUM & METAL OPTIONS	Drawn By: PLM
No. Revision Date	Date: 11/20/2019
#2 12/02/2019	Drawing No. N1.07
Description	Beleck Rev.



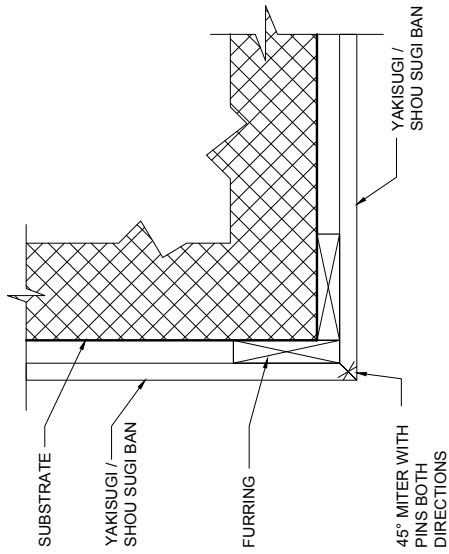

**A** PLAN VIEW - OUTSIDE CORNER - WOOD

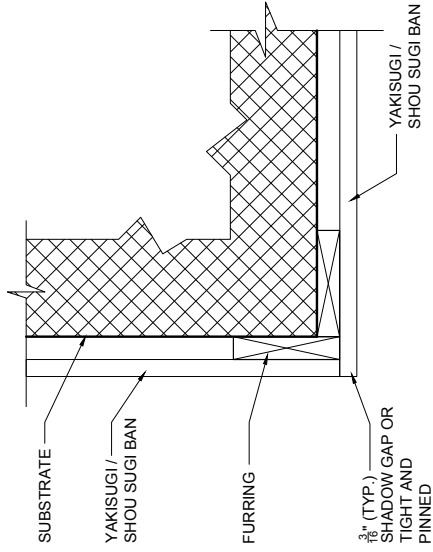

**B** PLAN VIEW - OUTSIDE CORNER - WOOD

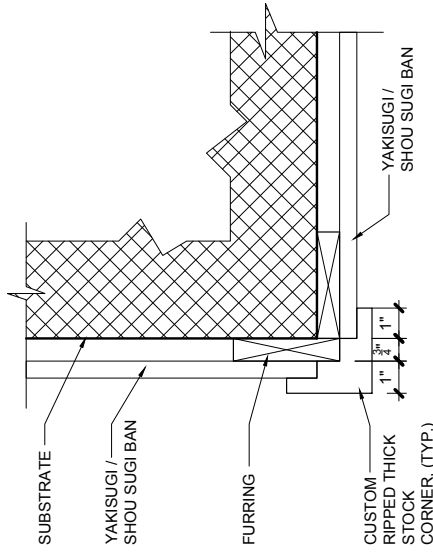

**C** PLAN VIEW - OUTSIDE CORNER - WOOD

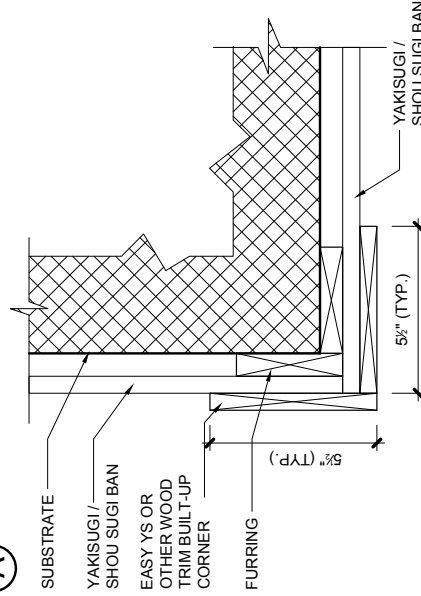

**D** PLAN VIEW - OUTSIDE CORNER - WOOD

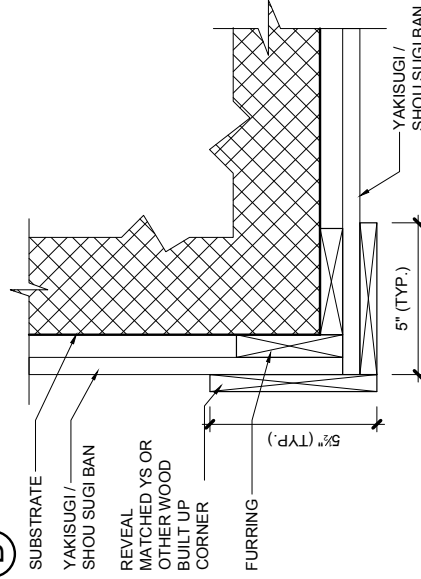

**E** PLAN VIEW - OUTSIDE CORNER - WOOD

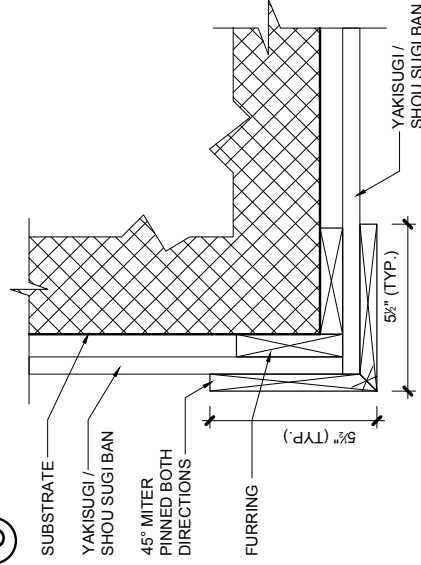

**F** PLAN VIEW - OUTSIDE CORNER - WOOD

**GENERAL NOTES:**

1. RECOMMENDED PANEL DETAIL EXAMPLES MUST BE ADAPTED FOR VERTICAL AND OTHER INSTALL LAYOUTS. FURRING AND HEADED FACE NAILS REQUIRED FOR ALL EXTERIOR INSTALLATIONS.
2. VERIFY ALL DIMENSIONS AND ELEVATIONS.
3. THESE DETAILS ARE NOT FOR CONSTRUCTION.
4. NAKAMOTO FORESTRY TAKES NO RESPONSIBILITY FOR THE DESIGN AND CONSTRUCTION OF CUSTOMER PROJECTS. THESE DRAWINGS ARE FOR EXAMPLE REFERENCE ONLY.

**NOT FOR CONSTRUCTION**



**NAKAMOTO FORESTRY**

Tel: +1-503-512-6780  
 Fax: +1-503-828-3665  
 Email: [info@nakamotoforestry.com](mailto:info@nakamotoforestry.com)  
 Warehouse & Office - (by Appt. ONLY)  
 6400 SE 101st Ave Unit 2C  
 Portland OR 97266

Project No.	000-000
Drawn By	PLM
Date	11/20/2019
Drawing No.	<b>N1.08</b>
No.	#2
Revision Date	12/02/2019
Description	Beleck Rev.
<b>EXTERIOR OUTSIDE CORNER WOOD OPTIONS - 1 OF 2 SHEETS</b>	

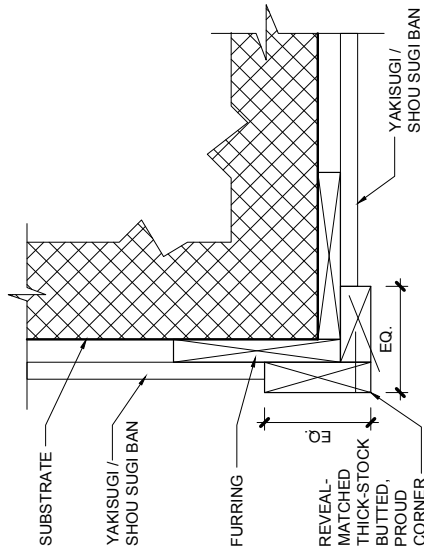

**A** PLAN VIEW - OUTSIDE CORNER - WOOD

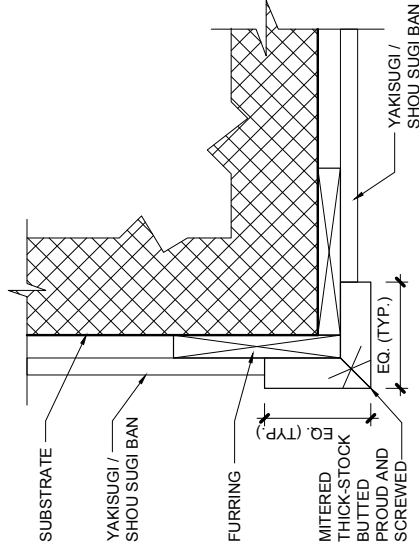

**B** PLAN VIEW - OUTSIDE CORNER - WOOD

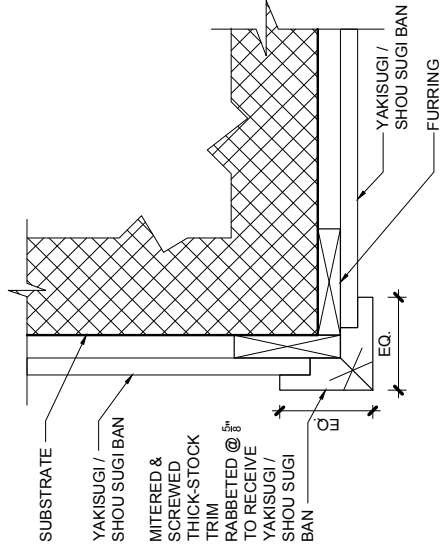

**C** PLAN VIEW - OUTSIDE CORNER - WOOD

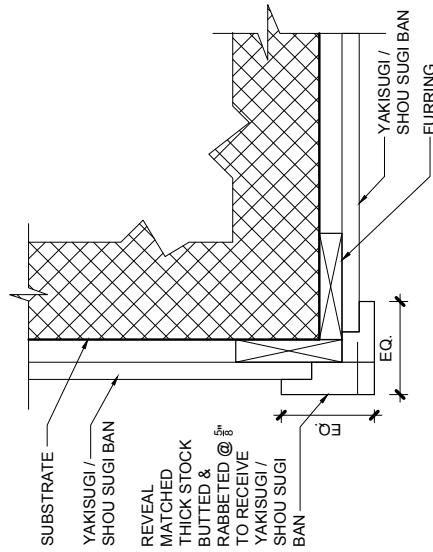

**D** PLAN VIEW - OUTSIDE CORNER - WOOD

**GENERAL NOTES:**

1. RECOMMENDED PANEL DETAIL EXAMPLES MUST BE ADAPTED FOR VERTICAL AND OTHER INSTALL LAYOUTS. FURRING AND HEADED FACE NAILS REQUIRED FOR ALL EXTERIOR INSTALLATIONS.
2. VERIFY ALL DIMENSIONS AND ELEVATIONS.
3. THESE DETAILS ARE NOT FOR CONSTRUCTION.
4. NAKAMOTO FORESTRY TAKES NO RESPONSIBILITY FOR THE DESIGN AND CONSTRUCTION OF CUSTOMER PROJECTS. THESE DRAWINGS ARE FOR EXAMPLE REFERENCE ONLY.

**NOT FOR CONSTRUCTION**

**NAKAMOTO FORESTRY**

Tel: +1-503-512-6780  
 Fax: +1-503-828-3665  
 Email: info@nakamotoforestry.com  
 Warehouse & Office - (by Appt. ONLY)  
 6400 SE 101st Ave Unit 2C  
 Portland OR 97266

Project Title:	EXTERIOR OUTSIDE CORNER WOOD OPTIONS, 2 OF 2 SHEETS	Project No.:	000-000
No.:	#2	Drawn By:	PLM
Revision Date:	12/02/2019	Date:	11/20/2019
Description:	Belecc Rev.	Drawing No.:	N1.09

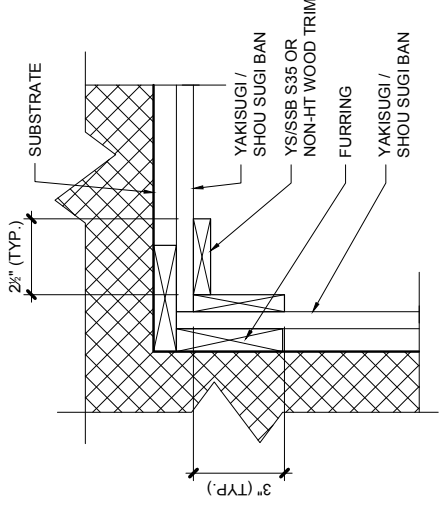

**A** PLAN VIEW INSIDE CORNER WOOD OPTIONS

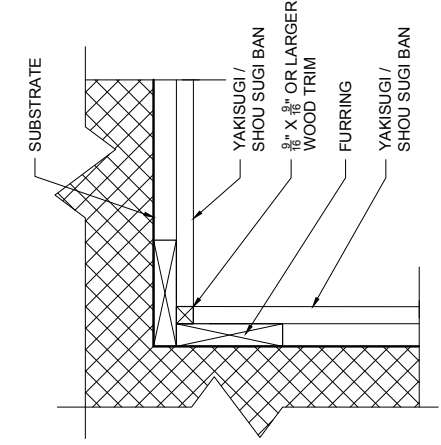

**B** PLAN VIEW INSIDE CORNER WOOD OPTIONS

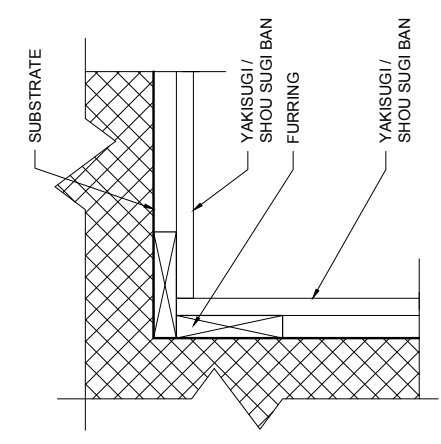

**C** PLAN VIEW INSIDE CORNER WOOD OPTIONS

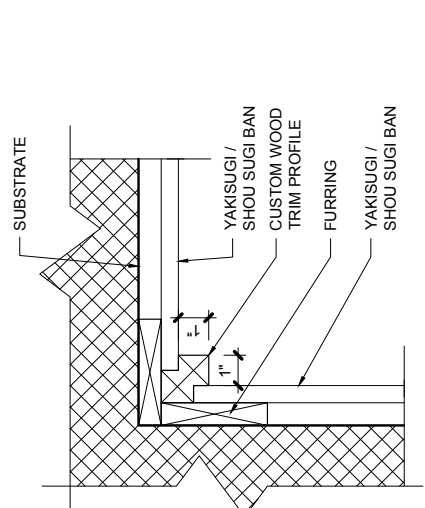

**D** PLAN VIEW INSIDE CORNER WOOD OPTIONS

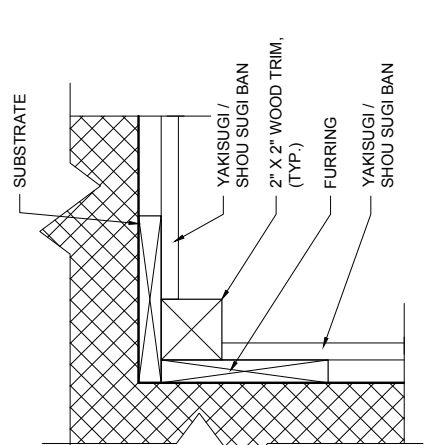

**E** PLAN VIEW INSIDE CORNER WOOD OPTIONS

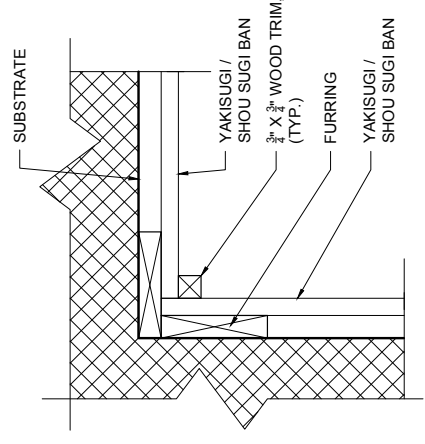

**F** PLAN VIEW INSIDE CORNER WOOD OPTIONS

**GENERAL NOTES:**

1. RECOMMENDED PANEL DETAIL EXAMPLES MUST BE ADAPTED FOR VERTICAL AND OTHER INSTALL LAYOUTS. FURRING AND HEADED FACE NAILS REQUIRED FOR ALL EXTERIOR INSTALLATIONS.
2. VERIFY ALL DIMENSIONS AND ELEVATIONS.
3. THESE DETAILS ARE NOT FOR CONSTRUCTION.
4. NAKAMOTO FORESTRY TAKES NO RESPONSIBILITY FOR THE DESIGN AND CONSTRUCTION OF CUSTOMER PROJECTS. THESE DRAWINGS ARE FOR EXAMPLE REFERENCE ONLY.

**NOT FOR CONSTRUCTION**

**NAKAMOTO FORESTRY**

Tel. +1-503-512-6780  
 Fax +1-503-828-3665  
 Email: info@nakamotoforestry.com  
 Warehouse & Office - (by Appt. ONLY)  
 6400 SE 101st Ave Unit 2C  
 Portland OR 97266

Project Title:	EXTERIOR INSIDE CORNER WOOD OPTIONS
Project No.:	000-000
Drawn By:	PLM
Date:	11/20/2019
Drawing No.:	N1.04
No.:	#3
Revision Date:	12/02/2019
Description:	Beleck Rev.

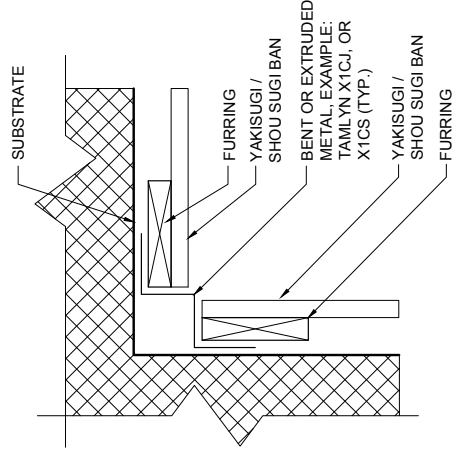
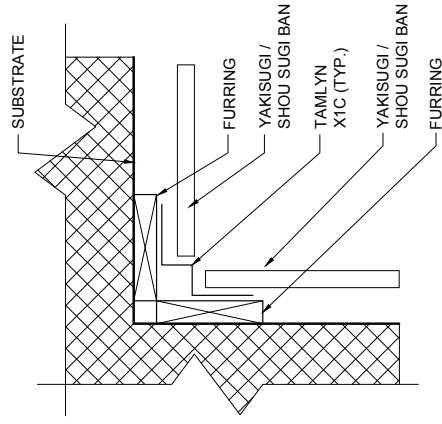

**A** PLAN VIEW ALUMINUM & METAL OPTIONS

**B** PLAN VIEW ALUMINUM & METAL OPTIONS

**GENERAL NOTES:**

1. RECOMMENDED PANEL DETAIL EXAMPLES MUST BE ADAPTED FOR VERTICAL AND OTHER INSTALL LAYOUTS. FURRING AND HEADED FACE NAILS REQUIRED FOR ALL EXTERIOR INSTALLATIONS.
2. VERIFY ALL DIMENSIONS AND ELEVATIONS.
3. THESE DETAILS ARE NOT FOR CONSTRUCTION.
4. NAKAMOTO FORESTRY TAKES NO RESPONSIBILITY FOR THE DESIGN AND CONSTRUCTION OF CUSTOMER PROJECTS. THESE DRAWINGS ARE FOR EXAMPLE REFERENCE ONLY.

**NOT FOR CONSTRUCTION**



**NAKAMOTO FORESTRY**

Tel: +1-503-512-6780  
 Fax: +1-503-828-9665  
 Email: info@nakamotoforestry.com  
 Warehouse & Office - (by Appt. ONLY)  
 6400 SE 101st Ave Unit 2C  
 Portland OR 97266

Project Title:		Project No. 000-000
EXTERIOR INSIDE CORNER ALUMINUM & METAL OPTIONS		Drawn By: PLM
		Date: 11/20/2019
No. Revision Date	Description	Drawing No.
#3 02/18/2020	Beleck Rev.	<b>N1.03</b>